

RAFFLES GIRLS' PRIMARY SCHOOL  
PRELIMINARY EXAMINATION  
PRIMARY SIX  
2023

MATHEMATICS  
PAPER 1  
(BOOKLET A)

Name: \_\_\_\_\_

Date : 24 August 2023

Class: P6 \_\_\_\_\_

Total Time : 1 hour

Math Teacher's Name : \_\_\_\_\_

INSTRUCTIONS TO CANDIDATES

1. Write your Index No. in the box at the top right hand corner.
2. Do not turn over this page until you are told to do so.
3. Follow all instructions carefully.
4. Answer all questions.
5. Use a 2B pencil to shade your answers on the Optical Answer Sheet (OAS).
6. The use of calculator is NOT allowed.

Paper 1	45
Paper 2	55
Total score out of 100	
Parent's signature	

Questions 1 to 10 carry 1 mark each. Questions 11 to 15 carry 2 marks each.  
For each question, four options are given. One of them is the correct answer.  
Make your choice (1, 2, 3 or 4). Shade your answer (1, 2, 3 or 4) on the OAS provided.  
(20 marks)

---

1. Which of the following is three million, four hundred and two thousand and five in numerals?

(1) 3 002 405

(2) 3 402 005

(3) 3 420 005

(4) 3 425 000

2. Arrange the following fractions from the smallest to the largest.

	<u>Smallest</u>		<u>Largest</u>
(1)	$\frac{3}{7}$ ,	$\frac{5}{8}$ ,	$\frac{1}{2}$
(2)	$\frac{1}{2}$ ,	$\frac{3}{7}$ ,	$\frac{5}{8}$
(3)	$\frac{5}{8}$ ,	$\frac{3}{7}$ ,	$\frac{1}{2}$
(4)	$\frac{3}{7}$ ,	$\frac{1}{2}$ ,	$\frac{5}{8}$

3. Part of a measuring tape is shown. What is the value represented by X?

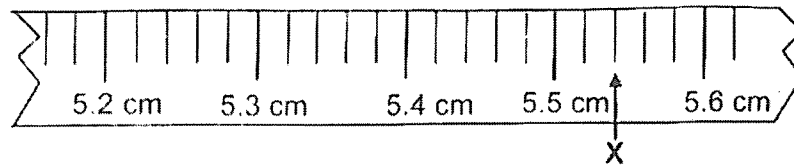

- (1) 5.502 cm  
(2) 5.504 cm  
(3) 5.52 cm  
(4) 5.54 cm
4. The tank with a base area  $300 \text{ cm}^2$  is partially filled with water. Find the volume of the water in the tank.

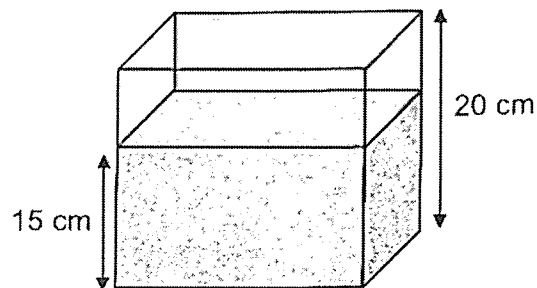

- (1)  $300 \text{ cm}^3$   
(2)  $1500 \text{ cm}^3$   
(3)  $4500 \text{ cm}^3$   
(4)  $6000 \text{ cm}^3$

5. DEFG is a rectangle. GHL and DHF are straight lines. Find  $\angle x$ .

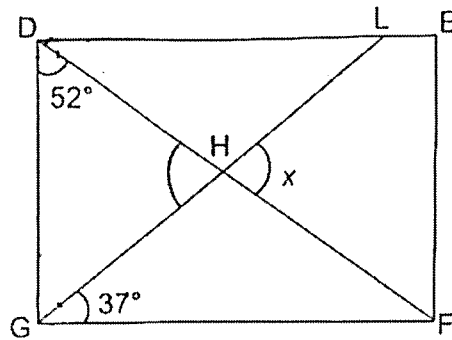

- (1)  $38^\circ$
- (2)  $53^\circ$
- (3)  $75^\circ$
- (4)  $90^\circ$

6. The figure shows a prism.

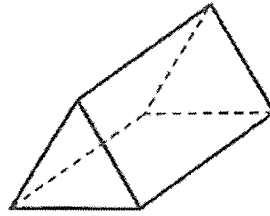

Which of the following is **not** the net of the prism?

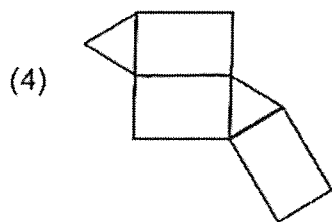
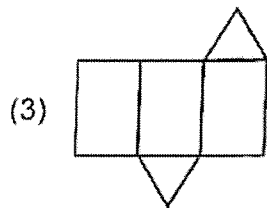
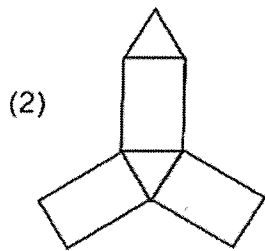
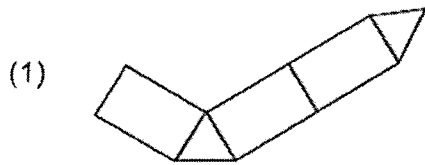

7. Which of the following is a possible height of a flag pole at the assembly ground?

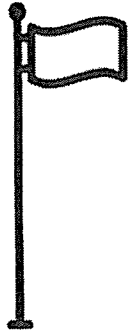

- (1) 6 cm  
 (2) 60 cm  
 (3) 6 m  
 (4) 60 m
8. Express  $3\frac{1}{20}$  as a decimal.

- (1) 3.01  
 (2) 3.05  
 (3) 3.2  
 (4) 3.5

9. Which of the following shows 25% of the figure shaded?

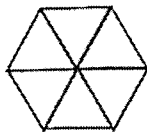

(1)

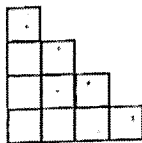

(2)

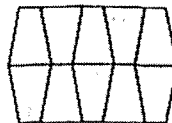

(3)

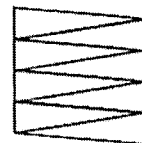

(4)

10. The first common multiple of 6 and 9 is \_\_\_\_\_.
- (1) 1
  - (2) 18
  - (3) 3
  - (4) 54
11. Find the value of  $y$  in  $50 + 5y = 110$ .
- (1) 12
  - (2) 32
  - (3) 60
  - (4) 72
12. Which of the numbers is closest to 1?
- (1) 0.85
  - (2) 0.93
  - (3) 1.05
  - (4) 2.09

13.

Carton	Number of toys	Percentage of toys which are defective
A	200	3%
B	300	8%

What percentage of the total number of toys in the cartons A and B are defective?

- (1) 1.2%
- (2) 5.5%
- (3) 6%
- (4) 11%

14. A baker used 800 g of flour and 150 g of sugar to bake a cake. Flour was sold in 900 g packets at \$5 per packet. Sugar was sold in 500 g packets at \$3 per packet. The baker wanted to bake 10 cakes. Which of the following pie chart shows the amount of money the baker spent on the ingredients?

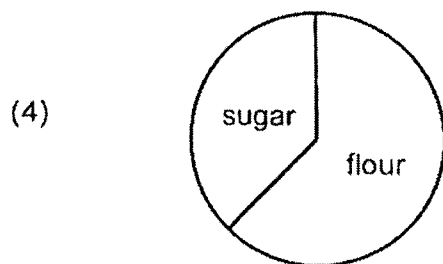
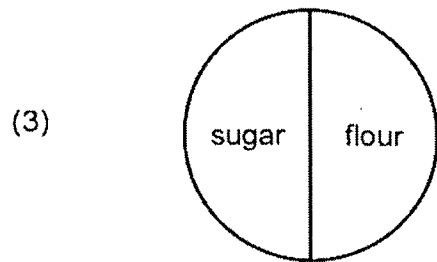
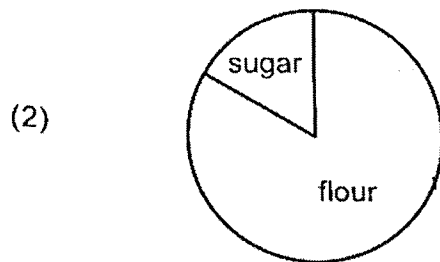
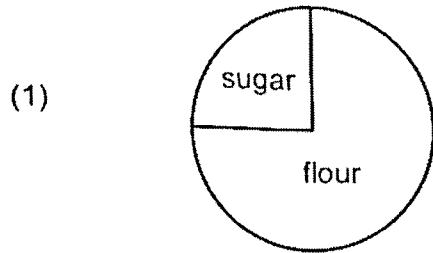



15. Mr Tan, an interior designer, tiled a square floor completely with square tiles of side 1 cm as shown in Figure 1. He used a total of 73 grey square tiles which formed a shape of an X as shown in Figure 2. Find the perimeter of the square floor.

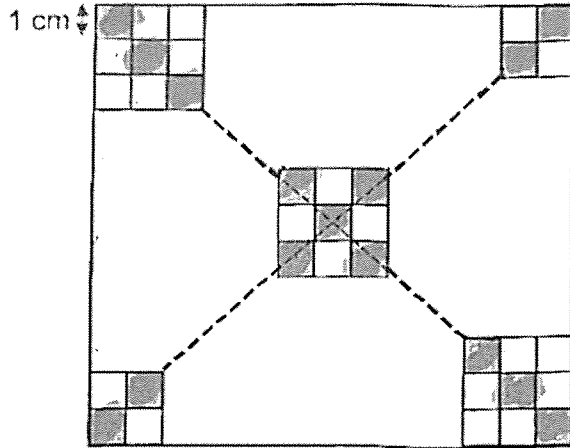

Figure 1

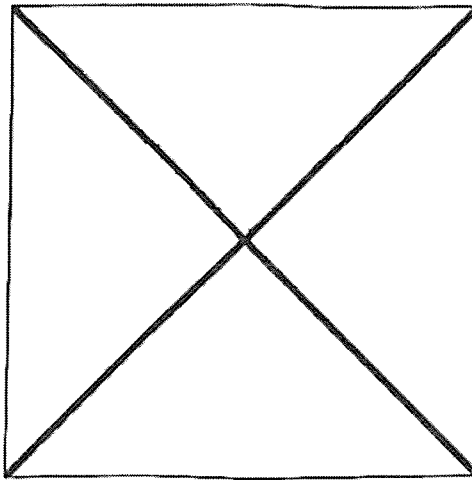
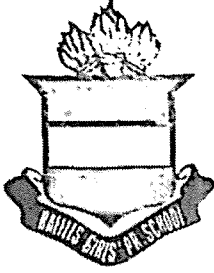

Figure 2

- (1) 68 cm
- (2) 144 cm
- (3) 148 cm
- (4) 224 cm

End of Paper  
 ☺ Please check your work carefully ☺



RAFFLES GIRLS' PRIMARY SCHOOL  
PRELIMINARY EXAMINATION  
PRIMARY SIX  
2023

MATHEMATICS  
PAPER 1  
(BOOKLET B)

Name: \_\_\_\_\_

Date : 24 August 2023

Class: P6 \_\_\_\_\_

Total Time : 1 hour

Math Teacher's Name : \_\_\_\_\_

INSTRUCTIONS TO CANDIDATES

1. Write your Index No. in the box at the top right hand corner.
2. Do not turn over this page until you are told to do so.
3. Follow all instructions carefully.
4. Answer all questions.
5. Use a dark blue or black ballpoint pen to write your answers in the space provided for each question.
6. Do not use correction fluid/tape or highlighters
7. The use of calculator is NOT allowed.

Questions 16 to 20 carry 1 mark each. Write your answers in the spaces provided. For questions which require units, give your answers in the units stated.

(5 marks)

16. Find the value of  $25 + (44 - 9) \div 5$ .

Ans: \_\_\_\_\_

17. Shelly watched a movie that was 3 h 5 min long. It ended at 22 30. At what time did the movie start? Give your answer in 24-hour clock.

Ans: \_\_\_\_\_

18. Express the mass of the watermelon as a mixed number in the simplest form.

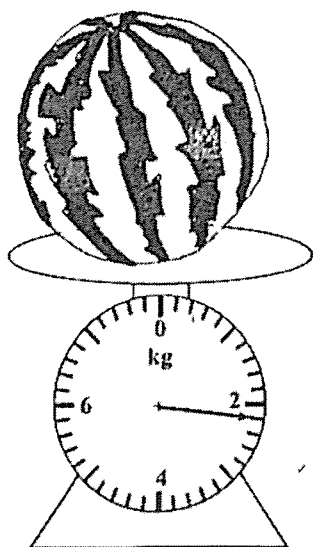

Ans: \_\_\_\_\_ kg

19. What is the missing number in the box?

$$9.582 = 9 + 0.2 + \boxed{\quad ? \quad} + 0.002$$

Ans: \_\_\_\_\_

20. The average of 4 numbers is 55. Three of the numbers are 0, 25 and 15.  
What is the 4<sup>th</sup> number?

Ans: \_\_\_\_\_

Questions 21 to 30 carry 2 marks each. Show your working clearly in the space provided for each question and write your answers in the space provided. For questions which require units, give your answers in the units stated.

(20 marks)

---

21. (a) Find the value of  $\frac{3}{4} + \frac{1}{6}$

Ans: (a) \_\_\_\_\_

(b) Find the value of  $12 \div \frac{3}{4}$

(b) \_\_\_\_\_

22. Miss Sheila mixed 3.6 l of water with 0.5 l of lemon juice to make lemonade. Then, she poured the lemonade equally into 5 jugs. How many ~~millimetres~~ <sup>millilitres</sup> of lemonade were there in each jug?

Ans: \_\_\_\_\_ ml

23. Shamil paid  $\$22x$  for 1 table and 3 chairs. The price of 1 chair was  $\frac{2}{5}$  of the price of the table. How much did he pay for 1 chair? Give your answer in terms of  $x$ .

Ans: \$ \_\_\_\_\_

24. Minni and 5 other girls shared the cost of a gift equally. When calculating the amount for each share, Minni made a mistake by dividing the cost of the gift by 4 instead of 6. Each girl paid \$12 more than her share. What should be the correct amount for each share?

Ans: \$ \_\_\_\_\_

25. The plan of a school is shown in the square grid.

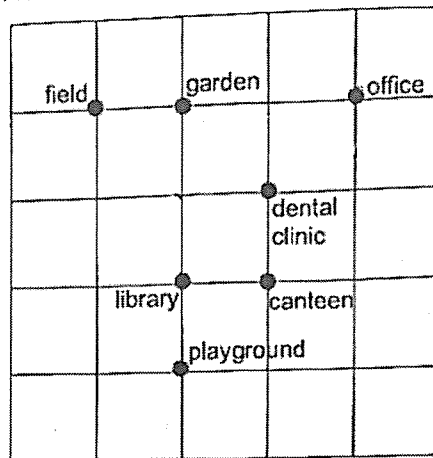

- (a) Devi walked directly from the canteen to the field in a straight line.  
In which direction did she walk?

Ans: (a) \_\_\_\_\_

- (b) Shi Ling stood at one of the locations facing the library. After she turned  $45^\circ$  anticlockwise, she faced the dental clinic.  
Which location was Shi Ling at?

b) \_\_\_\_\_

26. The figure below shows a square PQRS. PW and SQ are straight lines. The height of triangle PXQ is twice the height of triangle SXW.  $SW = WR$ . Given that the area of triangle SXW is  $14 \text{ cm}^2$ , find the area of triangle PXQ.

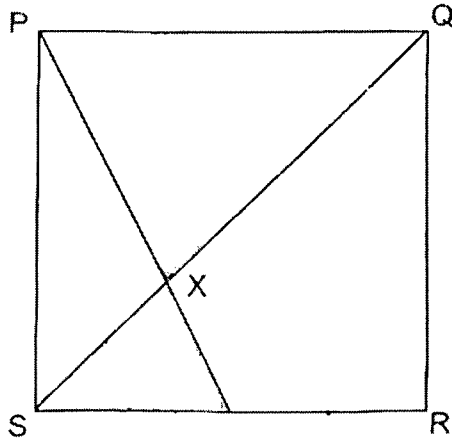

Ans: \_\_\_\_\_  $\text{cm}^2$



27. The graph shows the journey taken by Mary from Point A to Point C.

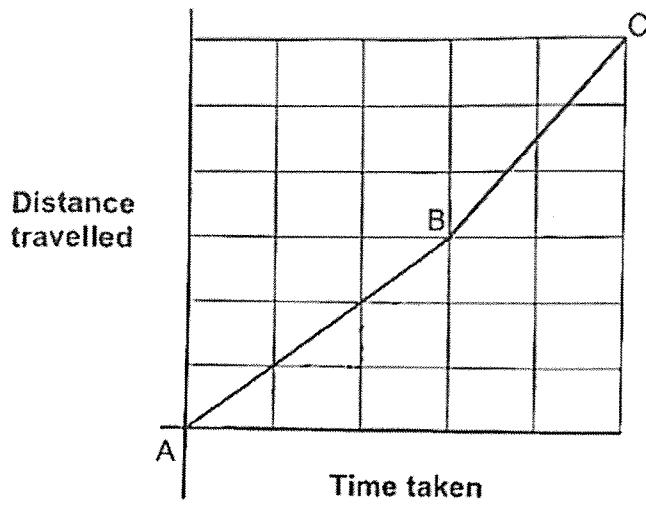

The distance between Point A and Point B is 24 km.

(a) What is the distance between Point A and Point C?

Ans: (a) \_\_\_\_\_ km

(b) Mary took 2 h to travel from Point B to Point C. What was Mary's average speed for the whole journey in km/h?

Ans: (b) \_\_\_\_\_ km/h

28. The pie chart shows the type of sandwiches sold at a canteen stall.  $\frac{1}{3}$  of the sandwiches sold were peanut butter sandwiches.

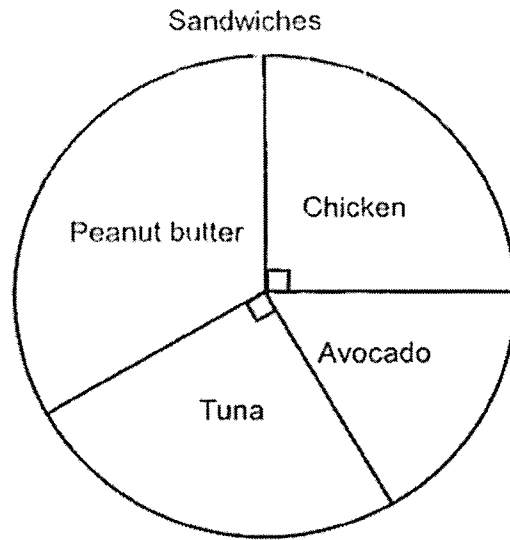

The types of sandwiches sold is also represented in the bar graph shown.

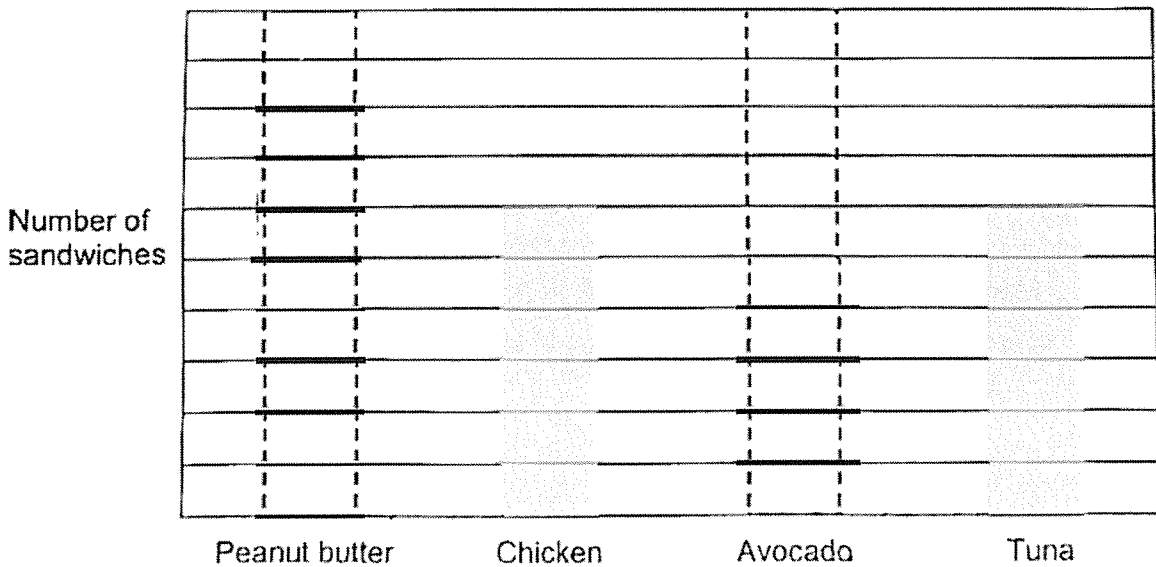

Draw the bars for the number of peanut butter sandwiches and avocado sandwiches sold in the bar graph.

29. Tim had \$1200 more than Jenny. After giving  $\frac{1}{3}$  of his money to Jenny, he had \$3400 left. How much money did Jenny have at first?

Ans: \$ \_\_\_\_\_

30. Elly, Nathan and Terence each had an equal number of paperweights. Elly had 9 metal weights and some wooden weights. The total mass of Elly's weights was 44.7 g. Terence only had wooden weights. Elly found that the total mass of her weights was 7.2 g more than Terence's weights. Nathan had 4 metal weights and some wooden weights. Find the total mass of Nathan's weights.

Ans: \_\_\_\_\_ g

**End of Paper**  
☺ Please check your work carefully ☺

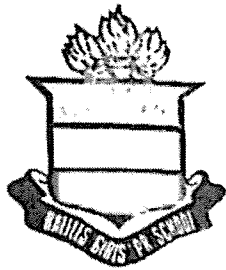

RAFFLES GIRLS' PRIMARY SCHOOL  
PRELIMINARY EXAMINATION  
PRIMARY SIX  
2023

**MATHEMATICS  
PAPER 2**

Name: \_\_\_\_\_

Date : 24 August 2023

Class: P6 \_\_\_\_\_

Total Time : 1 hour 30 min

Math Teacher's name : \_\_\_\_\_

**INSTRUCTIONS TO CANDIDATES**

1. Write your Index No. in the box at the top right hand corner.
2. Do not turn over this page until you are told to do so.
3. Follow all instructions carefully.
4. Answer all questions.
5. Use a dark blue or black ballpoint pen to write your answers in the space provided for each question.
6. Do not use correction fluid/tape or highlighters.
7. The use of an approved calculator is allowed.

Score	55
-------	----

Questions 1 to 5 carry 2 marks each. Show your working clearly in the space provided for each question and write your answers in the spaces provided. For questions which require units, give your answers in the units stated.

(10 marks)

1. The table shows the number of diners in a restaurant in the months of May, June and July. There was an increase of 22 diners from June to July.

	May	June	July
No. of diners	280	160	

What was the percentage decrease in the number of diners from May to July?

Ans : \_\_\_\_\_ % [2]

2. The pie chart shows the results of a survey on the favourite superhero of some pupils. One of the numbers in the table is covered by an ink blot.

Superhero	No. of pupils	Category
Wonder Woman	More than half	A
Ironman	30%	B
Thor		C
Superman	10%	D

Fill in the boxes in the pie chart with A, B, C, and D to represent the given data in the table. [2]

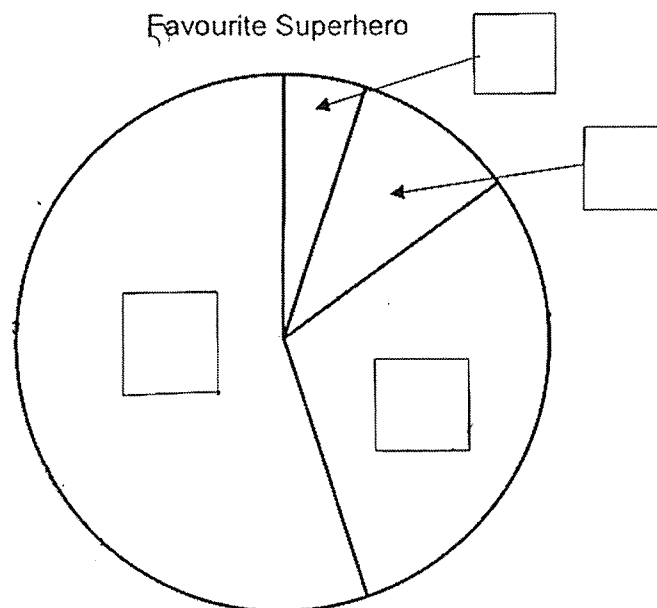

3. ABCD is a trapezium.  $\angle p = \angle q$ . Find the sum of  $\angle r$  and  $\angle s$ .

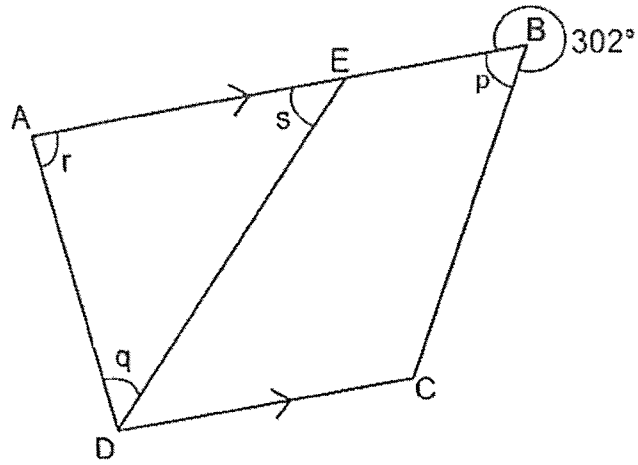

Ans : \_\_\_\_\_ $^\circ$  [2]

4. There was an equal number of boys and girls in the class.  $\frac{1}{2}$  of the girls and  $\frac{1}{4}$  of the boys wore spectacles. Find the ratio of the number of pupils who wore spectacles the total number of pupils.

Ans : \_\_\_\_\_ [2]



5. The table shows the cost of tickets and number of tickets sold at a carnival on a particular day. An adult ticket cost more than a child ticket.

Ticket	Cost (\$)	Number sold
Child	17	460
Adult	$s$	330

Each of the statements below is either true, false or not possible to tell from the information given. For each statement, put a tick(✓) to indicate your answer. [2]

Statement	True	False	Not possible to tell
(a) The total amount collected from the sale of tickets that day was $\$(330s + 7820)$ .			
(b) If an additional 130 adult tickets were sold, the amount collected from the sale of child tickets is less than the amount collected from that of adult tickets.			
(c) The amount collected from the sale of adult tickets was less than the amount collected from that of child tickets.			

For questions 6 to 17, show your working clearly in the space provided for each question and write your answers in the spaces provided.  
 The number of marks available is shown in the brackets [ ] at the end of each question or part-question.

Figures are not drawn to scale.

Answers in fractions or ratio must be expressed in the **simplest form**. (45 marks)

6. The shaded figure is made up of 6 big quarter arcs, 6 small quarter arcs and 2 straight lines. Find the area of the shaded part. (Take  $\pi = \frac{22}{7}$ )

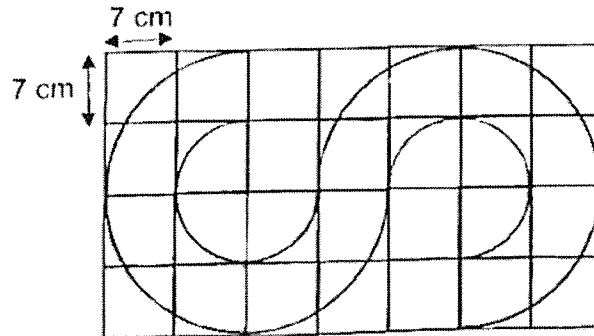

Ans : \_\_\_\_\_ [3]

7. A rhombus PQRS is drawn on a square grid.

(a) Draw square RSTU on the grid such that RSTU does not overlap with PQRS. [1]

(b) Using the line VW, draw trapezium VWXY such that it has the same area as PQRS. [2]

Use a pencil to draw your diagrams and label them clearly.

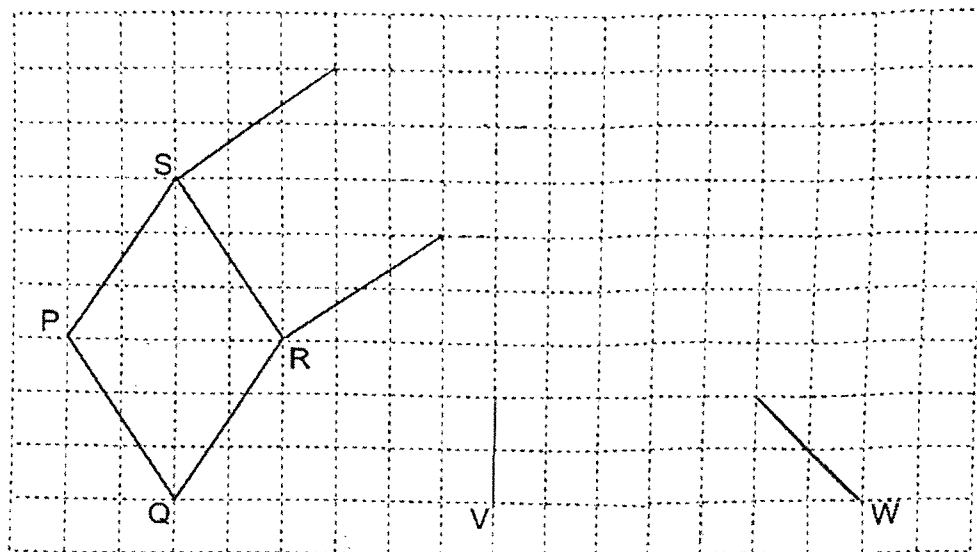

8. The sum of 3 numbers is 555. The 1<sup>st</sup> number is a 1-digit number, the 2<sup>nd</sup> number is a 2-digit number and the 3<sup>rd</sup> number is a 3-digit number.  
What is the smallest possible difference between the 2<sup>nd</sup> and 3<sup>rd</sup> number?

Answer : \_\_\_\_\_ [3]

9. Miss Siti bought an equal number of notebooks and pencils for her class. The notebooks were sold in packs of 8 for \$7 and the pencils were sold in packs of 5 for \$4.80. She paid \$293.60 in total. How many notebooks and pencils did she buy altogether?

Ans : \_\_\_\_\_ [3]

11. The table shows the fare a taxi company charges for their rides.

Distance Travelled	Rate
1 <sup>st</sup> km or less	\$3.90
Every additional 400 m or less up to 10 km	\$0.25

The distance from Mr Tan's home to his company was 9.8km.

- (a) Calculate the total fare that Mr Tan paid for the journey.

Ans: (a) \_\_\_\_\_ [2]

On a particular day, Mr Tan was late for work and decided to use Best Service Ride.

**Best Service Ride**

Distance Travelled	Rate
1 <sup>st</sup> km or less	\$6.00
Every additional 1 km or less	\$0.50

- (b) Calculate the total fare that Mr Tan paid for the same journey to his company.

Ans: (b) \_\_\_\_\_ [1]

10.

**Membership Promotion Coupon**

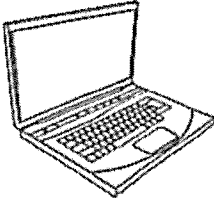

Buy first laptop at 10% discount  
Buy 2<sup>nd</sup> and subsequent laptops  
at 25% discount

***For non-members, buy each laptop at 5% discount***

Mr Lim is a member of the shop. He paid \$3115.20 for 3 laptops.

(a) What was the price of a laptop before discount?

Ans: (a) \_\_\_\_\_ [3]

(b) Mrs Muthu is not a member of the shop and she bought 1 laptop.  
How much did she pay?

(b) \_\_\_\_\_ [1]

12. The graph shows the number of cups of bubble tea left unsold in Bobby Bubble Tea shop.

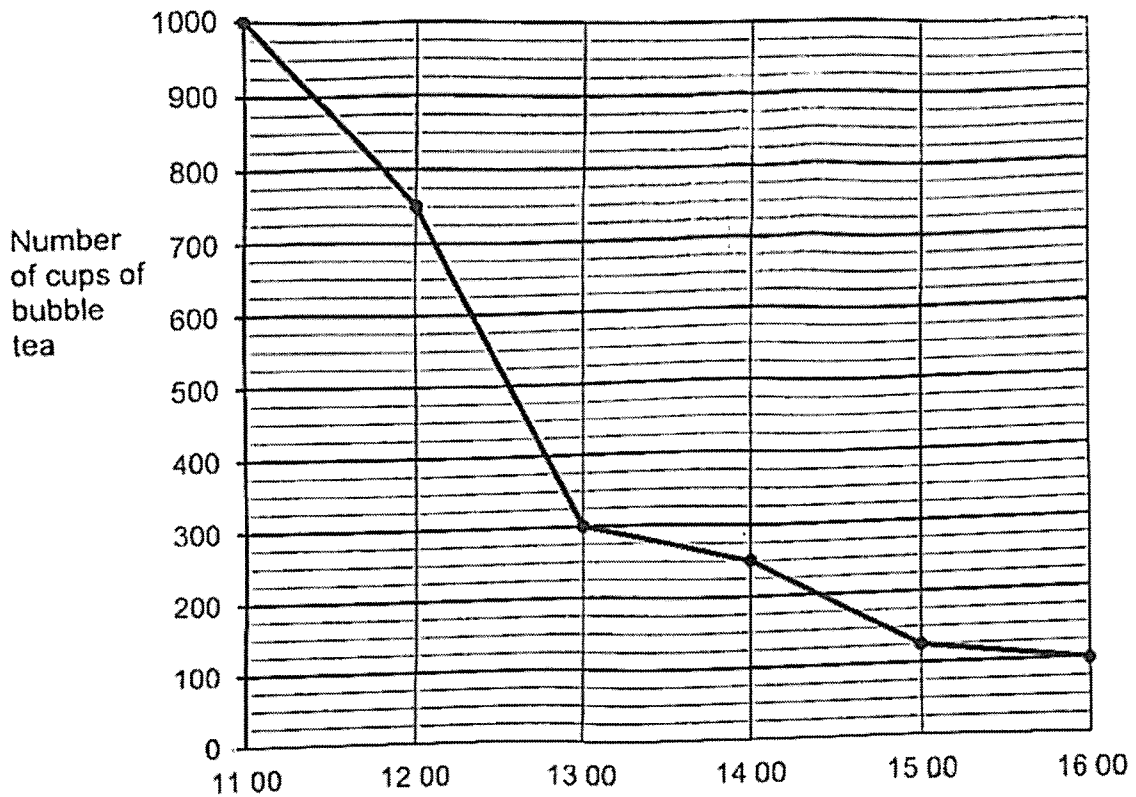

- (a) How many cups of bubble tea were sold from 11 00 to 12 00?

Ans: (a) \_\_\_\_\_ [1]

- (b) The cost of a cup of bubble tea was \$3.90. What was the average amount of money received per hour from selling the bubble tea between 12 00 to 15 00?

Ans: (b) \_\_\_\_\_ [3]



13. Gerry had a rectangular block of wood 15 cm by 8 cm by 20 cm. He painted all the faces of the block.

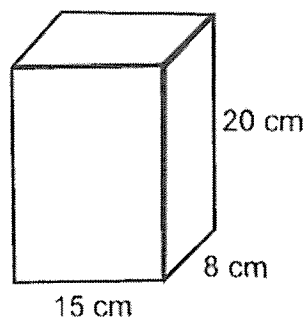

- (a) What is the total painted area?

Ans: (a) \_\_\_\_\_ [2]

- (b) Gerry cut the block into 1-cm cubes. How many of these cubes have 2 of the faces painted?

Ans: (b) \_\_\_\_\_ [2]

14. A triangular piece of paper ABC is folded along the two dotted lines.  
 $\angle ACB = 35^\circ$  and  $\angle AGD = 38^\circ$ .

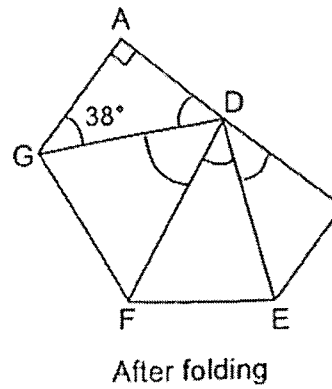
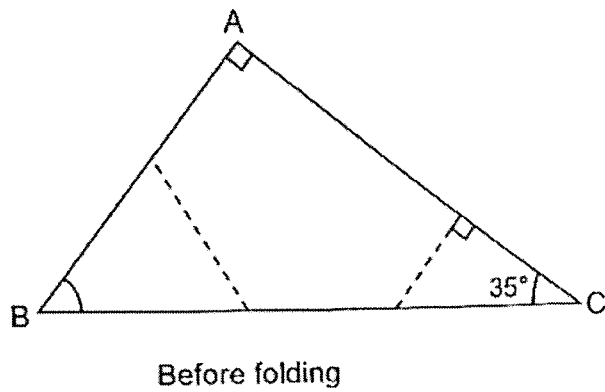

- (a) Find  $\angle ABC$ .

Ans: (a) \_\_\_\_\_ [1]

- (b) Find  $\angle FDE$ .

Ans: (b) \_\_\_\_\_ [3]

15. A figure is drawn on a piece of square paper with length 40 cm as shown. The figure is made up of 1 large quarter circle, 1 small quarter circle, 1 square and 4 straight lines.  $AB = 14$  cm, and  $BC = CD$ .

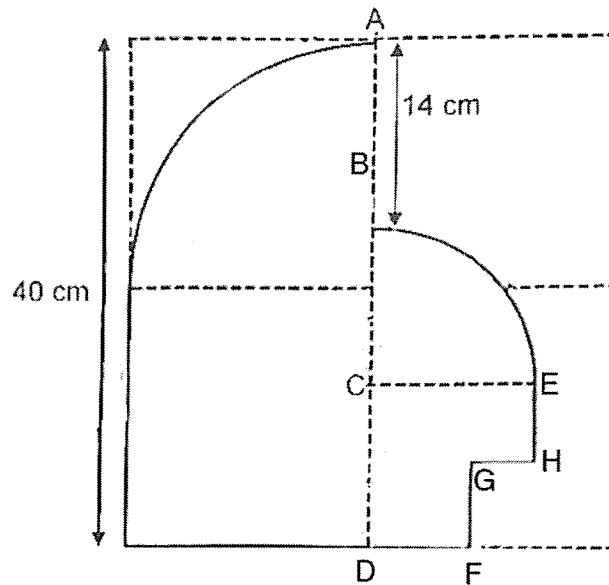

- (a) Find the length of BC.

Ans: (a) \_\_\_\_\_ [1]

- (b) What is the perimeter of the shaded figure ?  
(Take  $\pi = 3.14$ )

(b) \_\_\_\_\_ [3]

16. Jane bought 36 pies and Kelly bought 36 muffins. The total cost of all pies and muffins was \$576. Jane exchanged 6 pies with Kelly for 6 muffins. After the exchange, the total cost of the items Jane had to the total cost of the items Kelly had was 2:1.

(a) Find the cost of the items Kelly had after the exchange.

Ans: (a) \_\_\_\_\_ [2]

(b) What was the cost of 1 pie?

(b) \_\_\_\_\_ [3]

17. Mr Ravi spent  $\frac{1}{4}$  of his money on a shirt and  $\frac{5}{6}$  of his remaining money on a badminton racket, a pair of shorts and 2 pairs of shoes. The badminton racket cost 4 times as much as a pair of shoes while the pair of shorts cost  $\frac{2}{3}$  as much as a pair of shoes. The shirt cost \$84.30 more than the pair of shorts.

(a) What fraction of his money was spent on the pair of shorts?

Ans: (a) \_\_\_\_\_ [2]

(b) How much money did Mr Ravi spend altogether?

(b) \_\_\_\_\_ [3]

**End of Paper**  
**Please check your work carefully ☺**

SCHOOL : Raffles Girls' PRIMARY SCHOOL  
 LEVEL : PRIMARY 6  
 SUBJECT : MATH  
 TERM : Prelim 2023

**PAPER 1 BOOKLET A**

Q 1	Q2	Q3	Q4	Q5	Q6	Q7	Q8	Q9	Q10
2	4	4	3	3	1	3	2	4	2

Q 11	Q12	Q13	Q14	Q15
1	3	3	2	3

**PAPER 1 BOOKLET B**

Q16)	$25 + (44-9) \div 5$ $=25 + 35 \div 5$ $=25 + 7$ $=32$
Q17)	<p style="text-align: center;">1925                      1930                                      2230</p> $=1925$
Q18)	$\frac{2}{10} = 0.2 / \frac{2}{10} / \frac{1}{5}$ $2 + \frac{1}{5}$ $=2\frac{1}{5}$
Q19)	$9.582 - 0.200 - 0.002$ $=9.380 - 9.000$ $=0.380$

<p><b>Q20)</b></p>	<p><math>55 \times 4</math></p> <p><math>= 220 - 15 - 25 - 0</math></p> <p><math>= 220 - 40</math></p> <p><math>= 180</math></p>
<p><b>Q21)</b></p>	<p>(a) Find the value of <math>\frac{3}{4} + \frac{1}{6}</math></p> $\frac{3}{4} + \frac{1}{6} = \frac{9}{12} + \frac{2}{12}$ $= \frac{11}{12} \#$ <p>Ans: (a) <math>\frac{11}{12}</math> _____</p> <p>(b) Find the value of <math>12 + \frac{3}{4}</math></p> $\frac{12 \times 4}{1} + \frac{3}{4} = \frac{48}{1} + \frac{3}{4}$ $= 16 \#$ <p>(b) <math>16</math> _____</p>
<p><b>Q22)</b></p>	<p>total volume = <math>0.5 + 3.6</math></p> <p><math>= 4.1</math></p> <p><math>4.1 \text{ l} = 4100 \text{ ml}</math></p> <p>each inj = <math>4100 \div 5</math></p> <p><math>= 820 \#</math></p> <p>Ans: <math>820</math> _____ ml</p> $\begin{array}{r} 820 \\ 5 \overline{) 4100} \\ \underline{-40} \phantom{0} \\ 10 \phantom{0} \\ \underline{-10} \phantom{0} \\ 0 \phantom{0} \\ \underline{0} \phantom{0} \\ 0 \phantom{0} \\ \underline{0} \phantom{0} \\ 0 \phantom{0} \end{array}$

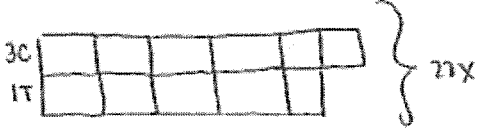
Q23)	 <p style="text-align: center;"> <math>114 = 27X</math>  <math>114 = 27X \div 11</math>  <math>= 2</math>  <math>10(211) = 2 \times 2</math>  <math>= 4</math>  <del>Ans: \$ 4x</del> </p>
Q24)	<p>check:</p> <p>24</p> <p><math>24 \times 6 = 144</math></p> <p><math>144 \div 4 = 36</math></p> <p><math>36 - 24 = 12</math> <input checked="" type="checkbox"/></p> <p style="text-align: right;">         amount for 2 = <math>4 \times 12</math>  <math>= 48</math>            amount for 1 = <math>48 \div 2</math>  <math>= 24</math> #       </p> <p style="text-align: right;">Ans: \$ <u>24</u></p>
Q25)	<p>a) North-west</p> <p>b) Garden</p>
Q26)	56cm <sup>2</sup>
Q27)	<p>a) <math>24 \div 3 = 8</math>  <math>8 \times 6 = 48</math>      Ans: 48</p> <p>b) <math>3 + 2 = 5</math>  <math>48 \div 5 = 9.6</math>      Ans: 9.6</p>
Q28)	<p><math>6 + 6 = 12</math></p> <p><math>12 \times 2 = 24</math></p> <p><math>24 \div 3 = 8</math> (Peanut Butter)</p> <p><math>12 - 8 = 4</math> (Tuna)</p>

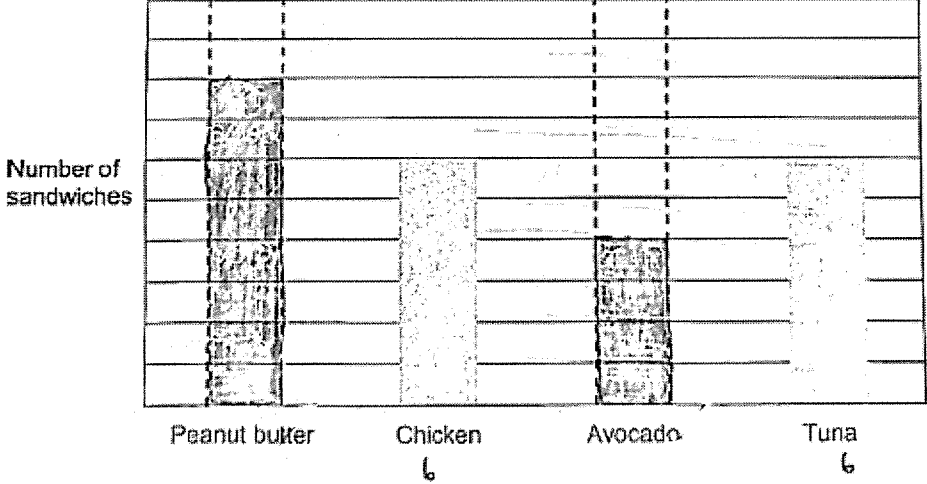

	 <p>Number of sandwiches</p> <p>Peanut butter      Chicken      Avocado      Tuna</p>
<p><b>Q29)</b></p>	$1 - \frac{1}{3} = \frac{2}{3}$ $\frac{2}{3} = 3400$ $3400 \div 2 = 1700$ $1700 \times 3 = 5100$ $5100 - 1200 = 3900$ <p><b>Ans: 3900</b></p>
<p><b>Q30)</b></p>	$44.7 - 7.2 + 37.5$ $7.2 \div 9 = 0.8$ $0.8 \times 5 = 4$ $44.7 - 4 = 40.7$ <p><b>Ans: 40.7</b></p>

**PAPER 2**

<p><b>Q1)</b></p>	$160 + 22 = 182$ $280 - 182 = 98$ $\frac{98}{280} \times 100 = 35$ <p><b>Ans: 35</b></p>
-------------------	--

**Q2)**

Favourite Superhero

A pie chart titled "Favourite Superhero" is divided into four segments labeled A, B, C, and D. Segment A is the largest, followed by B, then C, and D is the smallest. Arrows point from boxes labeled A, B, C, and D to their respective segments.

---

**Q3)**

$$\angle P = 360 - 302$$

$$= 58$$

$$\angle Q = 58$$

$$\angle V + \angle S = 180 - 58$$

$$= 122^\circ$$

---

**Q4)**

$$1n + 2n = 3n$$

$$4 \times 2 = 8n$$

Ans: 3 : 8

---

**Q5)**

Statement	True	False	Not possible to tell
(a) The total amount collected from the sale of tickets that day was $\$ (330s + 7820)$ .	✓		
(b) If an additional 130 adult tickets were sold, the amount collected from the sale of child tickets is less than the amount collected from that of adult tickets.	✓		
(c) The amount collected from the sale of adult tickets was less than the amount collected from that of child tickets.			✓

(a)

$$\text{total collected} = (5 \times 330) + (11 \times 460)$$

$$= 330s + 7820 \quad \# \text{ (a) } \square$$

Q6)

$$\begin{aligned} \text{AREA OF SHaded } \square &= \frac{1}{2} \times 6 \times \left(\frac{1}{4} \times \frac{22}{7} \times 7 \times 7\right) \\ &= 6 \times 38.5 \\ &= 231 \end{aligned}$$

$$\begin{aligned} \text{AREA OF 6 } \square &= 6 \times \left(\frac{1}{4} \times \frac{22}{7} \times 14 \times 14\right) \\ &= 6 \times 154 \\ &= 924 \end{aligned}$$

$$\begin{aligned} \text{AREA OF } \text{shaded shape} &= 924 - 231 \\ &= 693 \text{ cm}^2 \end{aligned}$$

Ans: 693 cm<sup>2</sup>

Q7)

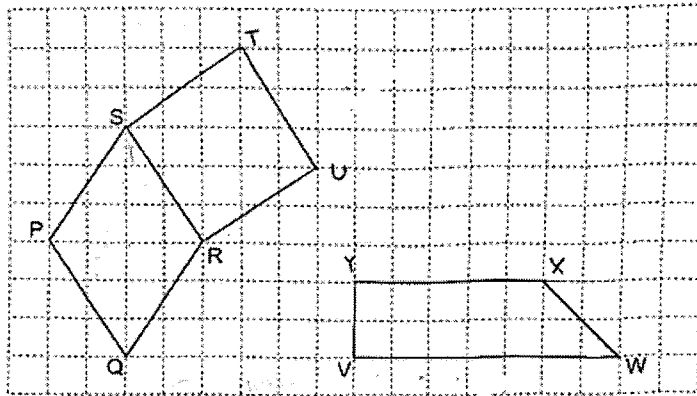

Q8)

$$555 - 9 - 99 = 447$$

$$447 - 99 = 348$$

Ans: 348

Q9)

$$36 \rightarrow 160$$

2

$$\begin{aligned} 1 &= 180 + 160 \\ &= 320 \text{ cm} \end{aligned}$$

$$8 : 8, 16, 24, 32, 40, 48, 56, 64, 72, 80, 88, 96, 104, 112, 120, 128, 136, 144, 152, 160$$

$$5 : 5, 10, 15, 20, 25, 30, 35, 40, 45, 50, 55, 60, 65, 70, 75, 80, 85, 90, 95, 100, 105, 110, 115, 120, 125, 130, 135, 140, 145, 150, 155, 160$$

$$50 \div 5 = 10$$

$$20 \times 7 = 140$$

$$160 \div 5 = 32$$

$$32 \times 4.8 = 153.6$$

$$153.6 + 140 = 293.6$$

$$170 \div 5 = 34$$

$$15 \times 7 = 109.5$$

$$170 \div 5 = 34$$

$$24 \times 4.8 = 115.2$$

$$115.2 + 105 = 220.2 \text{ cm}$$

$$80 \div 8 = 10$$

$$10 \times 7 = 70$$

$$80 \div 5 = 16$$

$$16 \times 4.8 = 76.8$$

$$76.8 + 70 = 146.8 \text{ cm}$$

Ans : 220 notebooks [3]  
and pencils

Q10)	<p>a) <math>90\% + 75\% + 75\% = 240\%</math>  <math>100\% - 25\% = 75\%</math>  <math>240\% = 3115.2</math>  <math>1\% = 3115.2 \div 240 = 12.98</math>  <math>100\% = 12.98 \times 100 = 1298</math>      ans: 1298</p> <p>b) <math>100\% - 5\% = 95\%</math>  <math>\frac{95}{100} \times 1298 = 1233.10</math>      ans: 1233.10</p>
Q11)	<p>a) <math>3.9 \times 1 = 3.9</math>  <math>9.8 - 1 = 8.8</math>  <math>8.8\text{km} = 8800\text{m}</math>  <math>8800 \div 400 = 22</math>  <math>22 \times 0.25 = 5.5</math>  <math>5.5 + 3.9 = 9.40</math>      ans: \$ 9.40</p> <p>b) <math>(9 \times 0.5) + 6 = 10.50</math>      ans: \$ 10.50</p>
Q12)	<p>a) <math>1000 - 750 = 250</math>      ans: 250 cups</p> <p>b) <math>750 - 125 = 625</math>  <math>625 \times 3.9 = 2437.5</math>    <math>2437.5 \div 3 = 812.50</math>      ans: \$ 812.50</p>
Q13)	<p>a) <math>2 \times (15 \times 20) = 600</math>  <math>(8 \times 15) \times 2 = 240</math>  <math>(8 \times 20) \times 2 = 320</math>  <math>600 + 240 + 320 = 1160</math>      ans: 1160cm<sup>2</sup></p> <p>b) <math>(13 \times 4) + (6 \times 4) + (18 \times 4) = 148</math>      ans: 148 cubes</p>
Q14)	<p>a) <math>180 - 90 - 35 = 55</math>      ans: 55°</p> <p>b) <math>180 - 52 - 55 - 35 = 38</math>      ans: 38°</p>
Q15)	<p>a) <math>40 - 14 = 26</math>  <math>26 \div 2 = 13</math>      ans: 13cm</p> <p>b) <math>\frac{1}{4} \times 3.14 \times 26 = 20.41</math>  <math>\frac{1}{4} \times 3.14 \times 40 = 31.4</math>    <math>31.4 + 20 + 20 + 13 + 13 + 20.41 + 14 = 131.81</math>      ans: 131.81cm</p>
Q16)	<p>a) <math>576 \div 3 = 192</math>      Ans: \$ 192</p>

	<p>b) <math>384 - 192 = 192</math>  <math>192 \div 24 = 8</math>  <math>8 \times 36 = 288</math>  <math>576 - 288 = 288</math>  <math>288 \div 72 = 4</math>  <math>4 + 8 = 12</math></p> <p style="text-align: right;">Ans: \$ 12</p>
Q17)	<p>a) <math>\frac{3}{4} = \frac{6}{8} = \frac{24}{32}</math></p> <p><math>\frac{5}{6} \times \frac{3}{4} = \frac{5}{8} = \frac{20}{32}</math></p> <p><math>= \frac{2}{32} = \frac{1}{16}</math></p> <p style="text-align: right;">Ans: <math>\frac{1}{16}</math></p> <p>b) <math>8n - 2n = 6n</math>  <math>6n = 8430</math>  <math>n = 84.30 \div 6</math>  <math>= 14.05</math></p> <p><math>28n = 28 \times 14.05</math>  <math>= 393.40</math></p> <p style="text-align: right;">Ans: \$ 393.40</p>