

**RAFFLES GIRLS' PRIMARY SCHOOL
END-OF-YEAR EXAMINATION
PRIMARY FIVE
2023**

**SCIENCE
(BOOKLET A)**

Name: _____ ()

Date : 26 October 2023

Class: P5 _____

Total Time: 1h 45min

INSTRUCTIONS TO CANDIDATES

1. Write your name, class and index number in the spaces provided above.
2. Do not turn over this page until you are told to do so.
3. Follow all instructions carefully.
4. Answer all questions.
5. For Question 1- 28, use 2B pencil to shade your answers on the Optical Answer Sheet (OAS).

Booklet A	56
Booklet B	44
Your score out of 100	
Parent's signature	

1. The diagram shows a process in human reproduction.

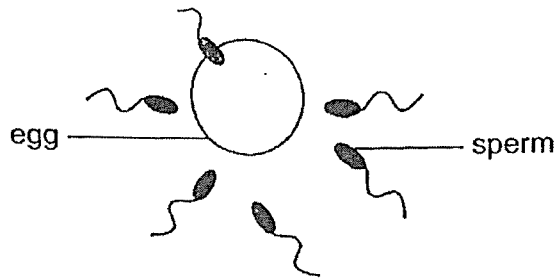

Which of the following statements about the process is **correct**?

- (1) It takes place every month.
- (2) It involves many sperms entering one egg.
- (3) The fertilised egg will develop in the ovary,
- (4) Fusion of sperm and egg results in a fertilised egg.

2. The diagram shows the inherited characteristic of having dimple in Cindy's family tree.

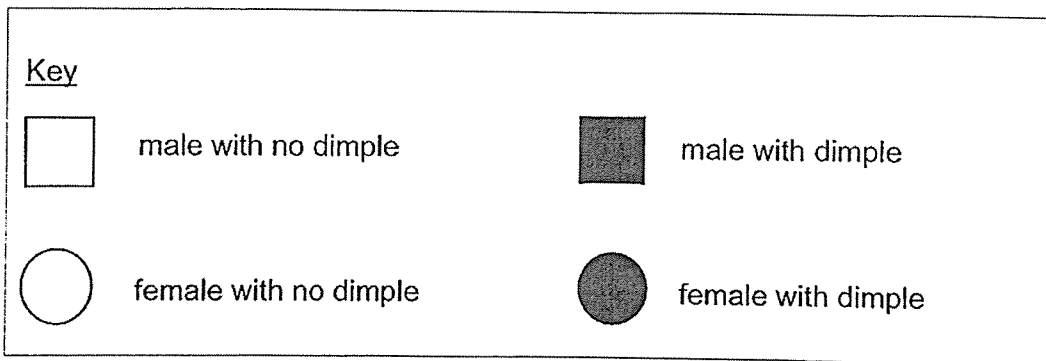
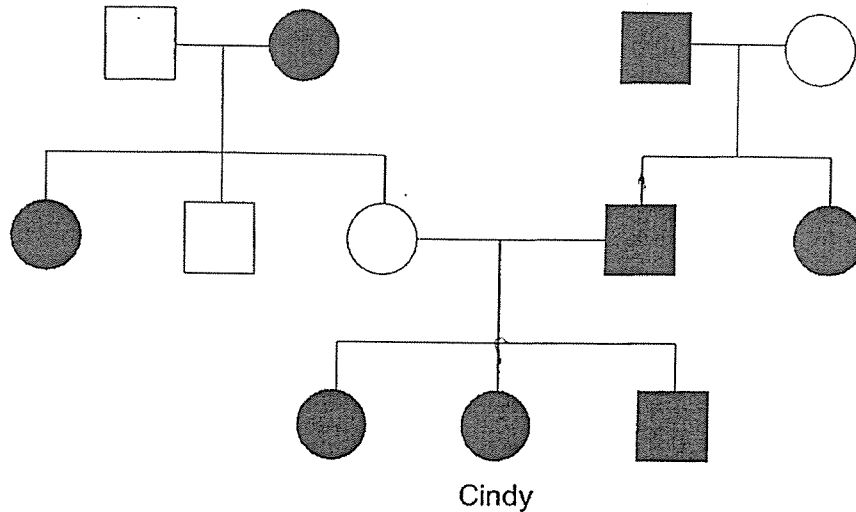

Which of the following statement(s) is/are true?

- A Both Cindy's siblings have dimples.
- B Cindy's father inherited the characteristic of dimple from his father.
- C Cindy inherited the characteristic of dimple from her father and mother.

- (1) A only
- (2) A and B only
- (3) B and C only
- (4) A, B, and C

3. The diagram shows the cross-section of a fruit developed from a flower of plant P.

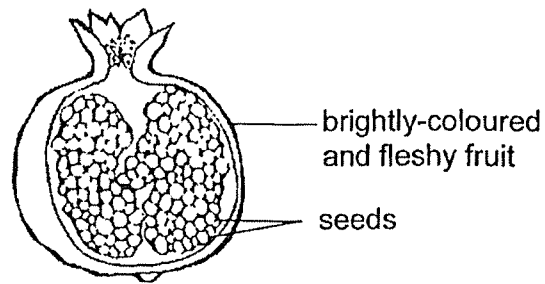

Based on the diagram, which of the following can be inferred about plant P?

- A Flower of plant P has many stigmas.
- B Pollination and fertilisation have taken place.
- C The ovary of flower P contains many ovules.
- D The seeds were small and would be dispersed by wind.

- (1) A and D only
- (2) B and C only
- (3) A, C and D only
- (4) B, C and D only

4. The diagram shows three flowers from the same plant with different parts of the flowers removed.

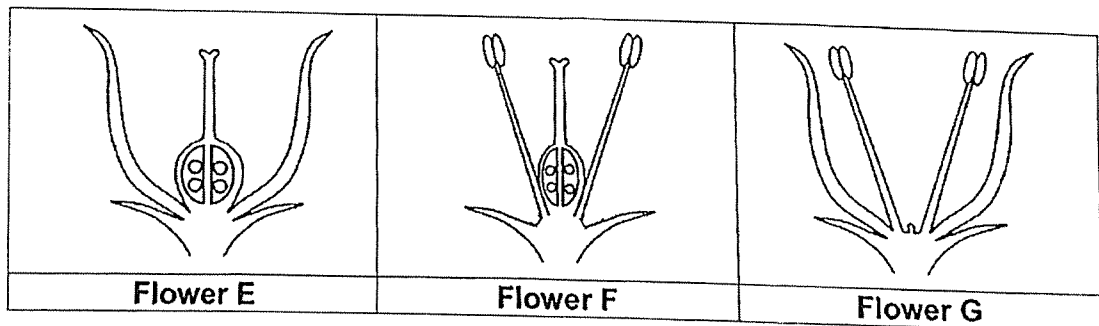

Which of the flower(s) will not be able to be fertilised and develop into a fruit?

- (1) Flower E only
- (2) Flower G only
- (3) Flowers E and F only ✓
- (4) Flowers E, F and G

5. The leaves of a plant were removed as shown in the diagram.

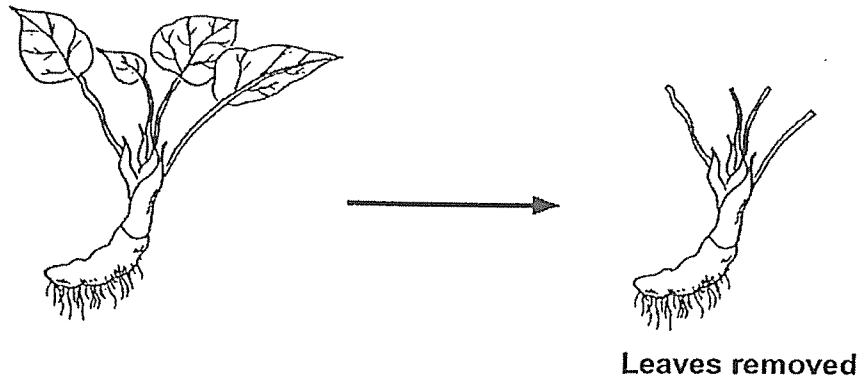

After a few days, the plant died. Which of the following is the correct reason for the observation?

- (1) The plant could not make food for itself.
 - (2) The plant could no longer take in water.
 - (3) The plant could no longer stand upright.
 - (4) The plant could not attract any pollinators.
6. The diagram shows two plants, J and K. Plant J grows around a pole while plant K grows around a tree trunk.

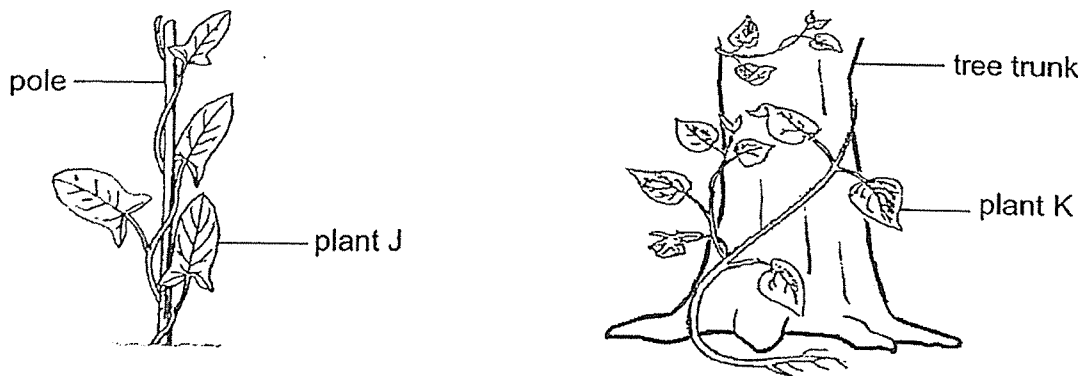

Based on the diagrams, which of the following statements is true?

- (1) Both plants cannot make its own food.
- (2) Plant J has a weak stem but plant K has a strong stem.
- (3) Both plants need a support to grow towards the sunlight.
- (4) Plant J absorbs water from the soil but plant K absorbs water from the tree trunk.

7. The diagram shows the human digestive system.

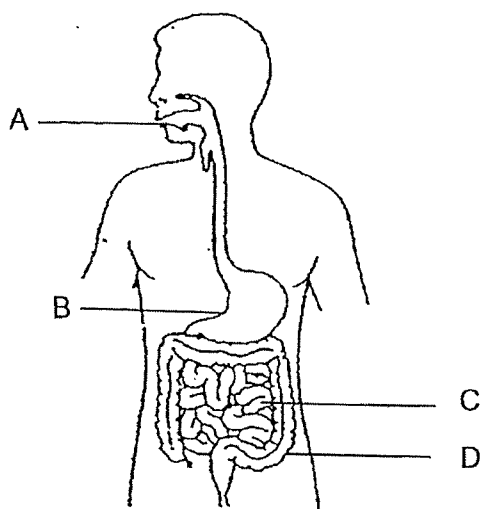

Which of the following is correct?

	Digested food is absorbed into the blood stream	Water is absorbed from the undigested food
(1)	A	B
(2)	B	C
(3)	C	D
(4)	D	A

8. The diagram shows how food and gases are transported in the human body.

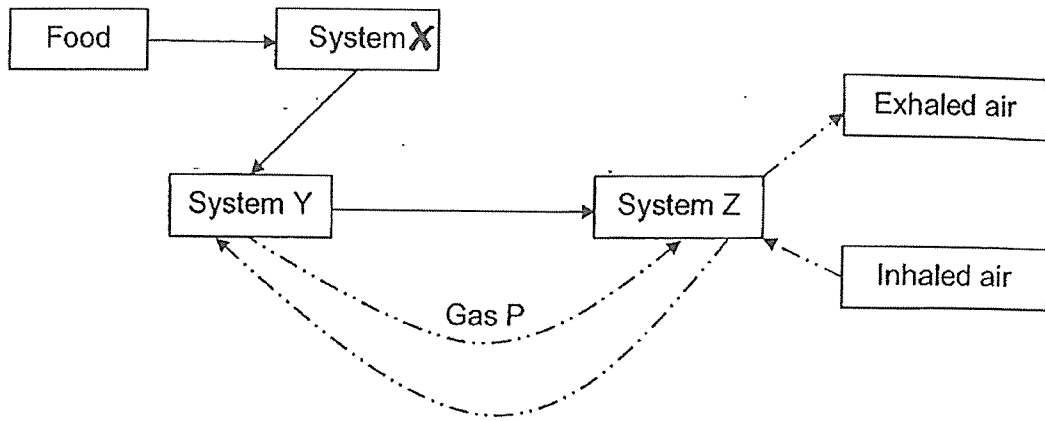

Key:
 —————> Path taken by food
 - - - - -> Path taken by gases

Which human body systems do X, Y and Z represent and what is gas P?

	System X	System Y	System Z	Gas P
(1)	Digestive	Skeletal	Muscular	Oxygen
(2)	Circulatory	Digestive	Skeletal	Carbon dioxide
(3)	Digestive	Circulatory	Respiratory	Carbon dioxide
(4)	Muscular	Respiratory	Circulatory	Oxygen

9. The diagram below shows how sand is separated from water using a filter paper. The filter paper only allows water to pass through it.

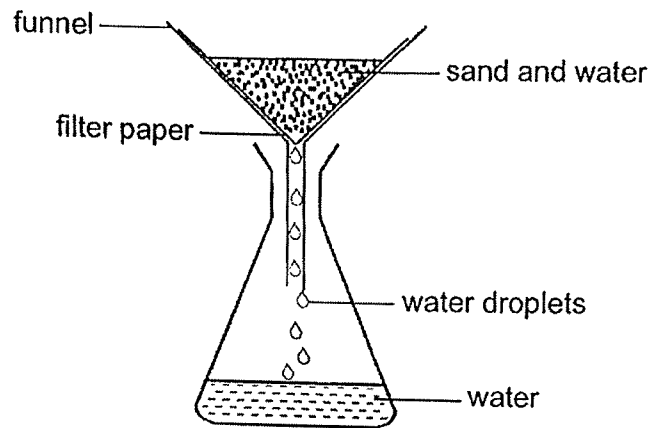

Which part of a plant cell has a similar function as the filter paper?

- (1) Nucleus
 - (2) Cell Wall
 - (3) Chloroplasts
 - (4) Cell Membrane
10. Lisa made some statements about plants, fish and humans.
- A Gaseous exchange takes place in the lungs, gills and leaves.
 - B Fish and humans take in food through the mouth and plants take in mineral salts through the roots.
 - C Humans have blood vessels to transport digested food to all parts of the body while plants have tubes to transport food to all parts of the plant.

Which of her statement(s) is/are correct?

- (1) A only
- (2) B only
- (3) A and C only
- (4) A, B and C

11. Ahmad recorded his heart rate while resting and running as shown in the table.

Activity	Heartbeat rate (beats per minute)
Resting	70
Running	180

Which of the following provides the correct reason for the heartbeat rate?

	Activity	Heartbeat rate (beats per minute)	Reason
(1)	Resting	70	Less carbon dioxide, transported in the blood, is needed by the cells to release energy.
(2)	Resting	180	More oxygen, transported in the blood, is needed by the cells to release energy.
(3)	Running	70	Less carbon dioxide, transported in the blood, is needed by the cells to release energy.
(4)	Running	180	More oxygen, transported in the blood, is needed by the cells to release energy.

12. Study the flowchart shown.

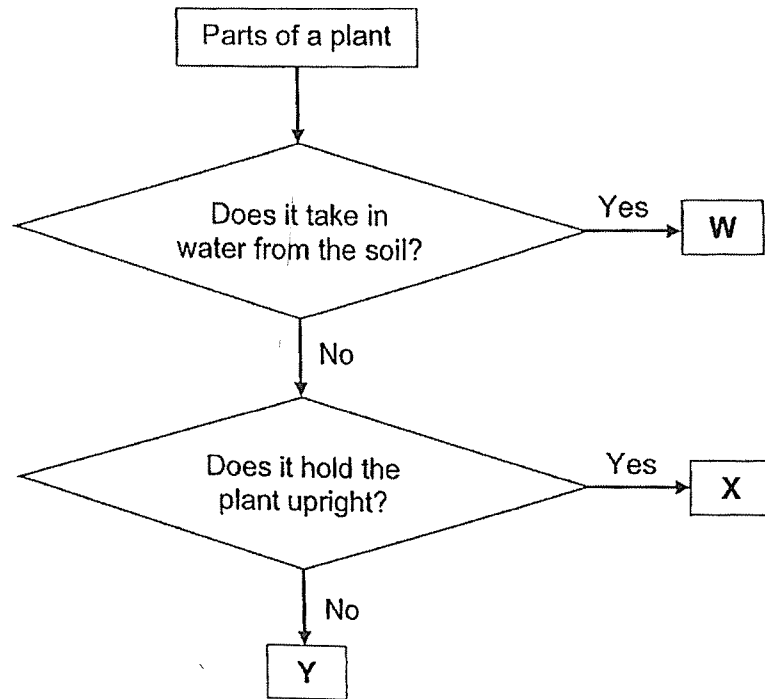

Which of the following identifies parts W, X and Y of a plant correctly?

	W	X	Y
(1)	Roots	Leaf	Stem
(2)	Roots	Stem	Leaf
(3)	Stem	Roots	Leaf
(4)	Stem	Leaf	Roots

13. The diagrams show four set-ups A, B, C and D, containing stems taken from the same plant and placed into measuring cylinders with 50cm^3 of water. The set-ups were exposed to the same temperature for twenty-four hours.

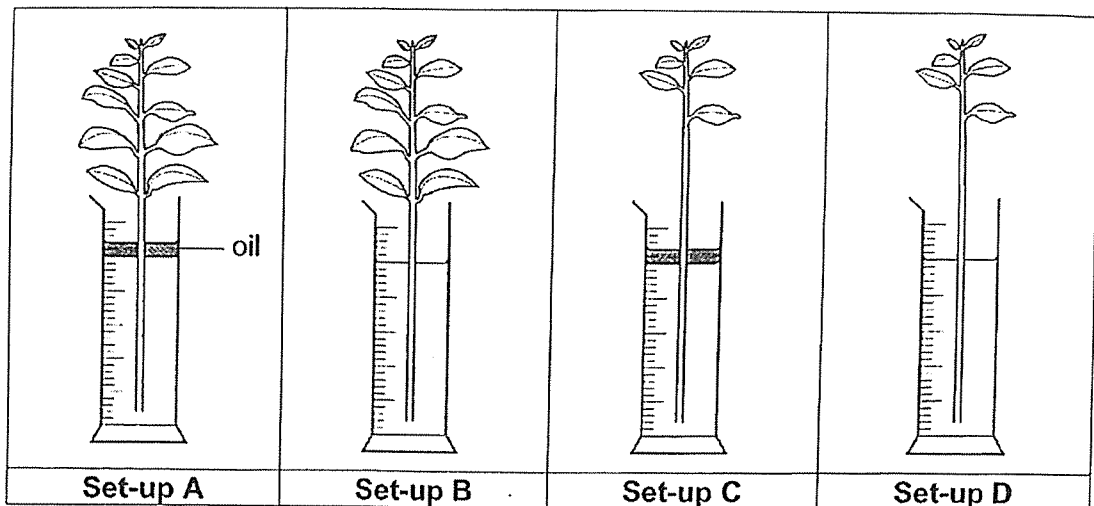

The table shows the final volume of water left in set-ups A, B and C after twenty-four hours.

Set-up	Presence of layer of oil	Final volume of water (cm^3)
A	Yes	40
B	No	28
C	Yes	44
D	No	?

Which of the following shows the likely final volume of water in set-up D after twenty-four hours?

- (1) 50cm^3
- (2) Less than 28cm^3
- (3) Greater than 44cm^3
- (4) Between 28cm^3 and 40cm^3

14. Substance X is a solid at 30 °C and a gas at 190°C.

Which of the following most likely shows the melting and boiling points of X?

	Melting point of X (°C)	Boiling point of X (°C)
(1)	25	180
(2)	25	200
(3)	35	180
(4)	35	200

15. The diagram shows the change in state of water.

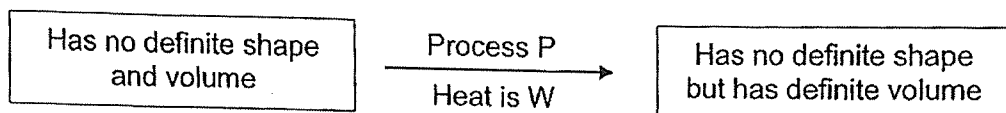

Which of the following correctly represents P and W in the above reaction process?

	P	W
(1)	Evaporation	gained
(2)	Evaporation	lost
(3)	Condensation	gained
(4)	Condensation	lost

16. Vera wants to find out how the surrounding temperature affects the rate of evaporation of water in a container.

She prepares four identical containers, A, B, C and D, filled with the same amount of water.

The table shows the different conditions the containers of water are exposed to.

Container	Exposed surface area (cm ²)	Surrounding temperature (°C)	Wind speed (km/h)
A	40	15	12
B	40	25	12
C	50	25	13
D	40	35	12

Which of the following set-ups should Vera use for her experiment?

- (1) A and C only
- (2) B and C only
- (3) A, B and D only
- (4) A, C and D only

17. Ali heated a beaker of water at room temperature until it boiled. The beaker of water was then left on the kitchen table to cool. The results are shown in the graph.

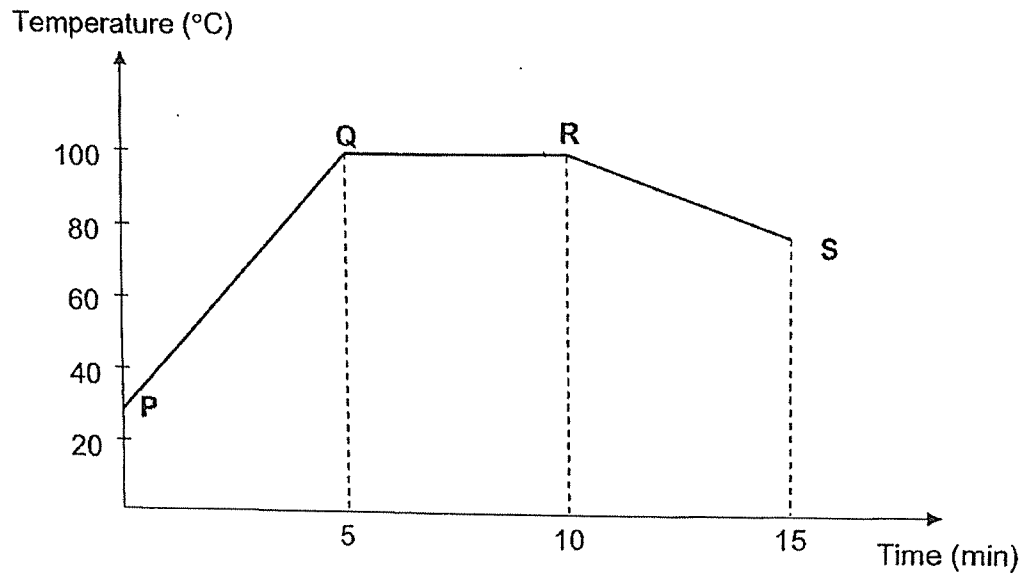

Based on the information, which of the following statement(s) is/are correct?

- A Water was boiling for five minutes.
- B Water gained heat at PQ and QR.
- C The temperature of water continued to decrease after fifteen minutes until it reached 10°C.

- (1) B only
- (2) A and B only
- (3) B and C only
- (4) A, B and C

18. The diagram shows a girl looking at a butterfly.

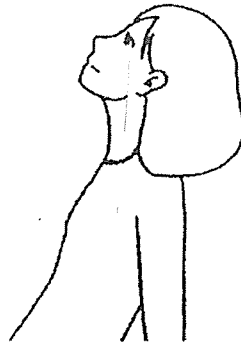
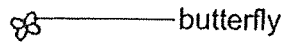

Which of the following correctly shows the path of light (represented by the arrows) which enabled the girl to see the butterfly?

(1)

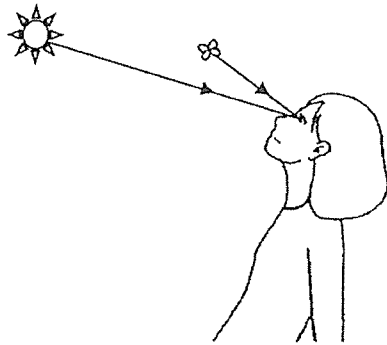

(2)

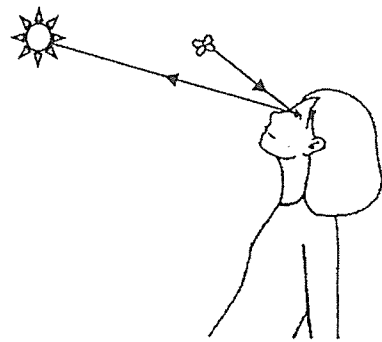

(3)

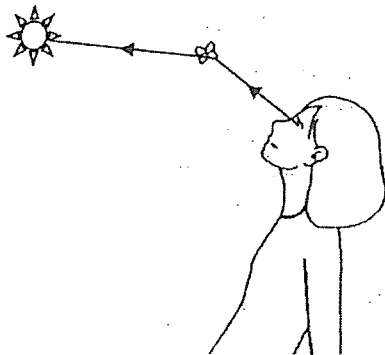

(4)

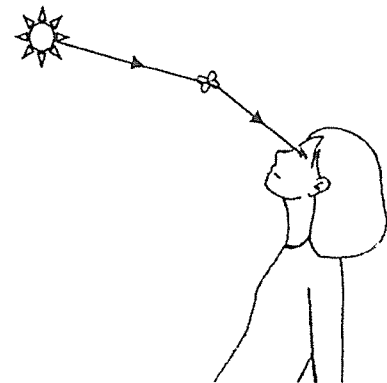

19. The diagram shows a saucepan.

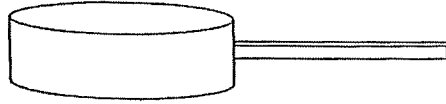

Which of the following show the possible shadows casted by the saucepan?

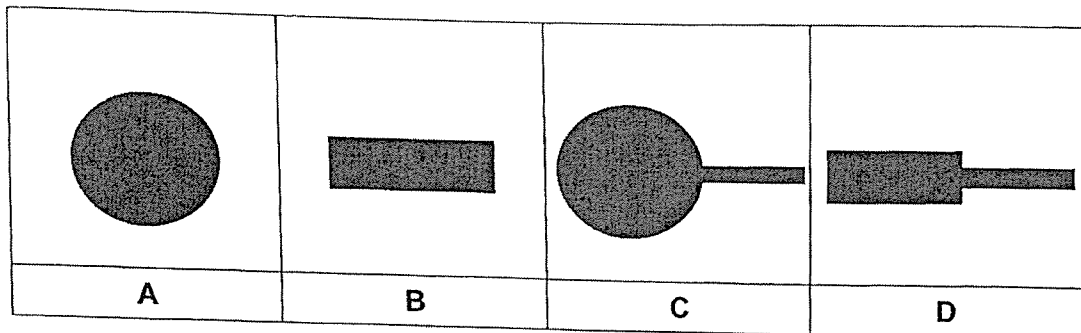

- (1) A and B only
- (2) A and C only
- (3) C and D only
- (4) B, C and D only

20. The diagram shows a torch shining on three objects, A, B and C, made of identical material but of different shapes. They are placed at different distances from the torch.

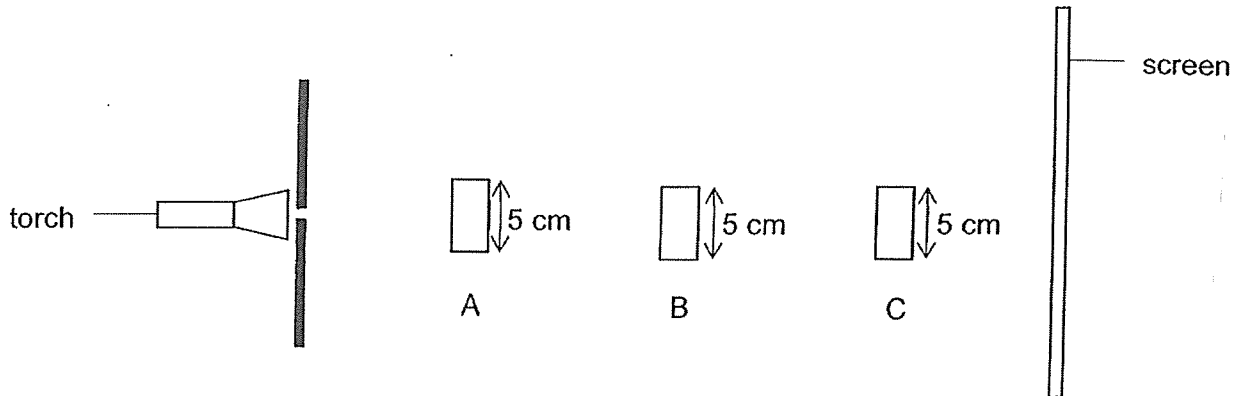



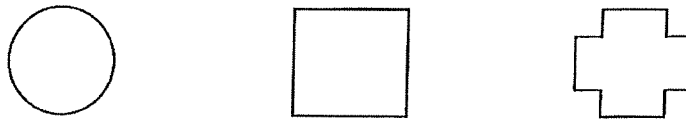

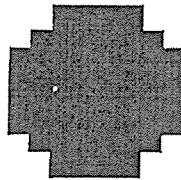

The following shows the shapes of the objects.

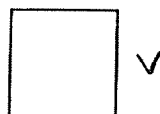
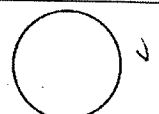
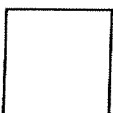
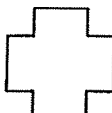

The diagram below shows the shadow cast on the screen.

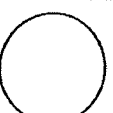

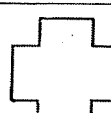
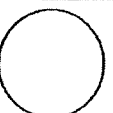
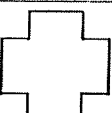
Which of the following correctly represents objects A, B and C?

	A	B	C
(1)			
(2)			
(3)			
(4)			

21. The diagram shows a flask containing hot water.

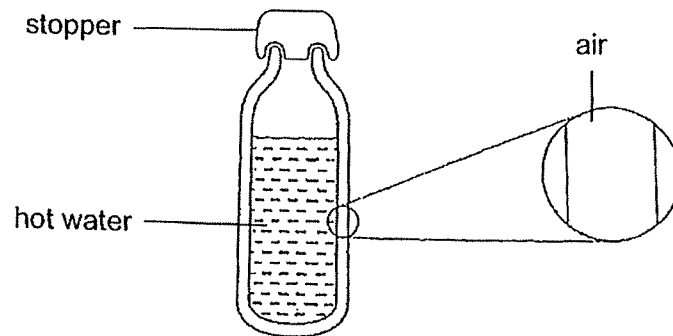

Based on the information, which of the following statement(s) is/are correct?

- A The stopper slows down heat loss from the hot water to the surrounding air outside the flask.
- B The trapped air in the flask slows down heat loss from the hot water to the surrounding air outside the flask.
- C The trapped air in the flask is a good conductor of heat and conducts heat from the surrounding air to the hot water quickly.

- (1) A only
- (2) C only
- (3) A and B only
- (4) B and C only

22. In the laboratory, Peter prepared two containers, X and Y, filled with the same amount of water at 30°C. He placed containers X and Y into two basins containing different amount of boiling water as shown in the diagram.

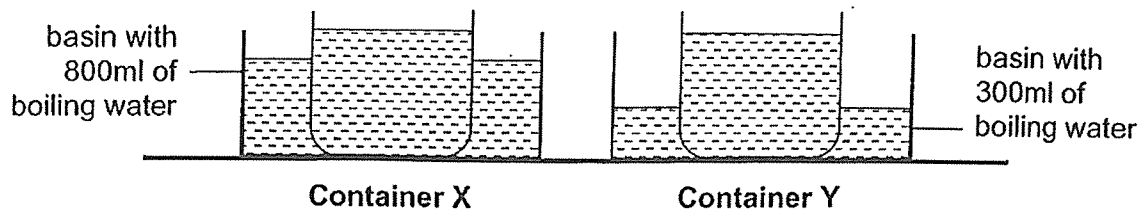

The temperatures of water in containers X and Y were recorded every minute for some time.

Which of the following shows the correct graph for the temperatures of water in containers X and Y?

(1)

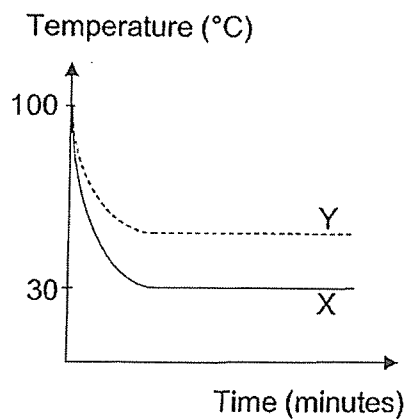

(2)

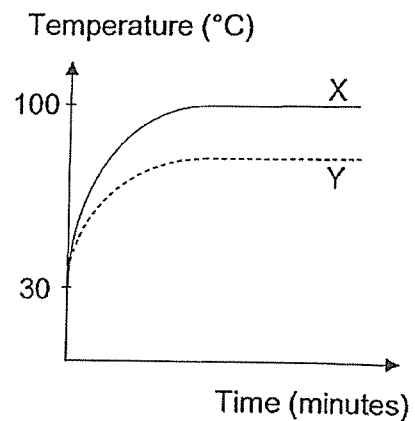

(3)

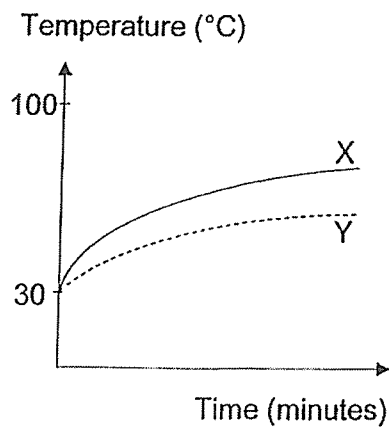

(4)

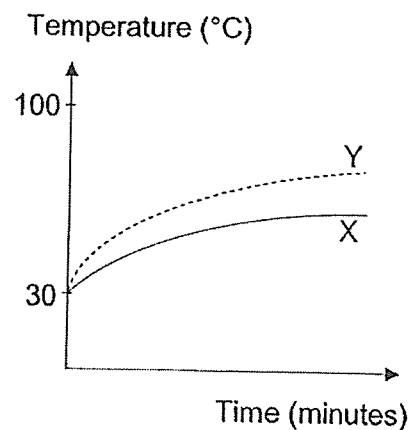

23. Siti wants to find out if the material of a spoon affects the rate at which the piece of butter melts.

She prepares a set-up using a spoon with a piece of butter and placed it into a cup of hot water as shown in the diagram.

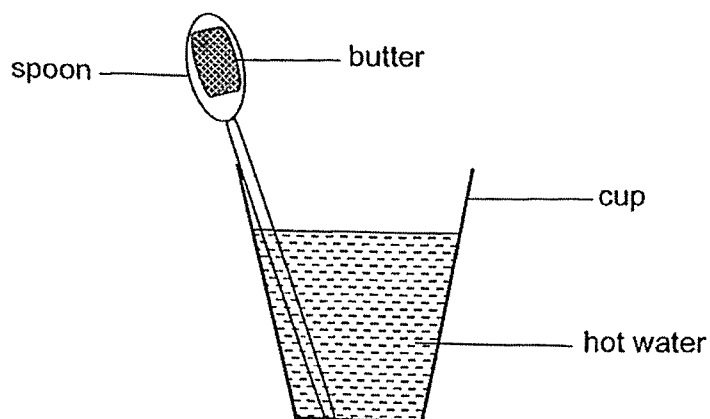

The table shows the conditions set-ups A, B, C and D are exposed to.

Set-up	Amount of water (ml)	Temperature of water (°C)	Material of spoon	Presence of wind
A	50	90	Plastic	Present
B	50	90	Aluminium	Present
C	100	90	Glass	Absent
D	50	80	Ceramic	Present

Based on the information, which two set-ups should Siti use for her investigation?

- (1) A and B only
- (2) A and C only
- (3) B and D only
- (4) C and D only

24. A circuit as shown in the diagram is set up to test the electrical conductivity of materials P and Q.

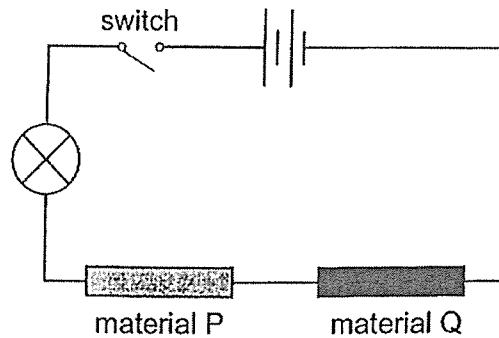

When the switch is closed, the bulb lights up. Which of the following likely represents materials P and Q?

	Material P	Material Q
(1)	Copper	Wood
(2)	Copper	Iron
(3)	Glass	Wood
(4)	Wood	Iron

25. A circuit is set up as shown.

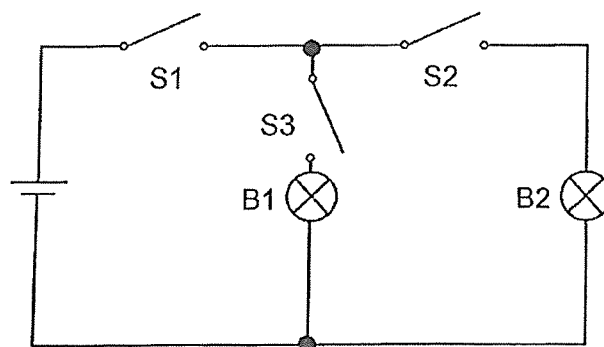

Which switch(es) must be closed to light lamp B1 only?

- (1) S1 only
- (2) S1 and S2 only
- (3) S1 and S3 only
- (4) S2 and S3 only

26. The diagram shows a toy robot with a head lamp and two eyes that can light up. The head lamp and eyes are connected to the same battery.

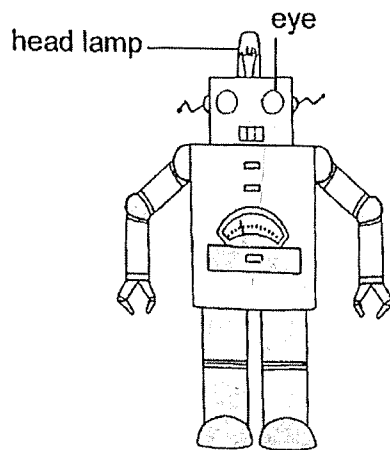

Two switches are used to control the head lamp and eyes separately. The eyes are connected in series.

Which of the following correctly shows the electrical circuit found in the toy?

(1)

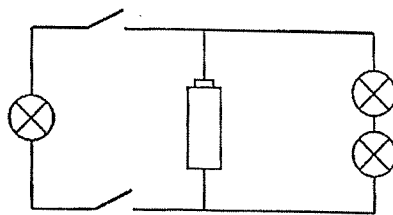

(2)

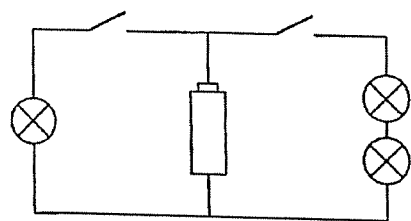

(3)

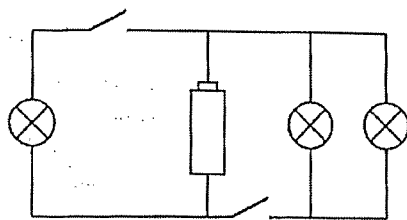

(4)

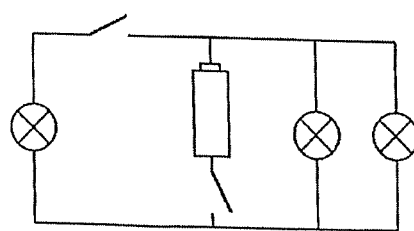

27. Irene has a bar magnet. She placed pins of identical mass at each point, P, Q and R. She replaced each pin with a greater mass and recorded the greatest mass of the pins that could be attached to the magnet without falling off, as shown in the diagram.

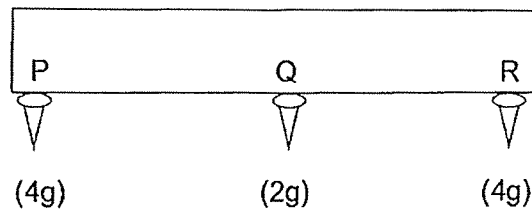

Which of the following can be concluded from the results?

- A Point R is the South pole of the magnet.
- B The pins are made of magnetic material.
- C Point Q of the magnet is weaker than points P and R.

- (1) A only
- (2) B only
- (3) B and C only
- (4) A, B and C

28. The diagram shows an iron bar AB that is magnetised using the stroking method.

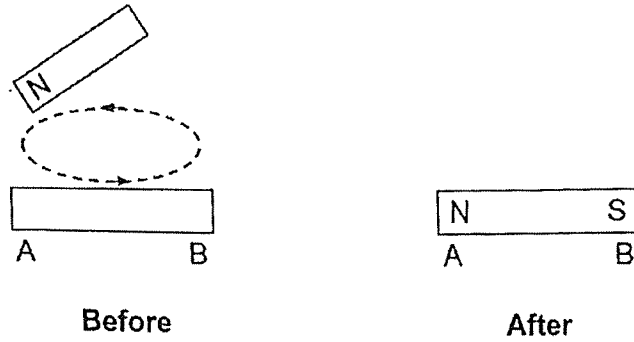

Another iron bar, PQ, was magnetised using the same magnet.

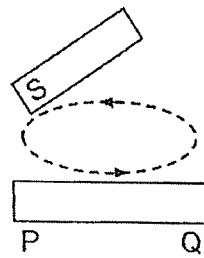

Which of the following diagrams shows a possible arrangement of iron bars AB and PQ after they were magnetised?

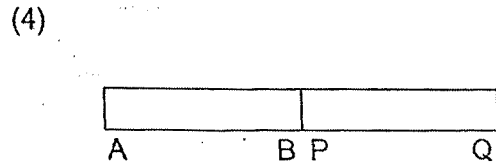
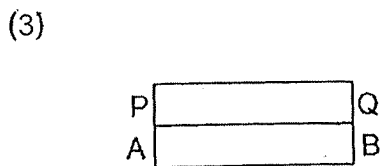
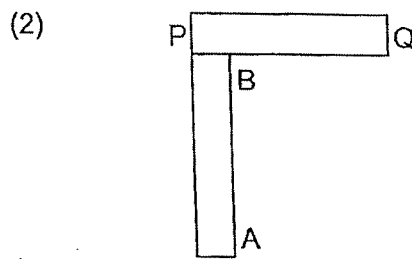
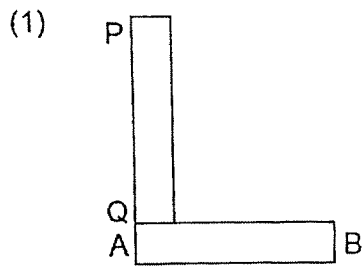



RAFFLES GIRLS' PRIMARY SCHOOL
END-OF-YEAR EXAMINATION
PRIMARY FIVE
2023

SCIENCE
(BOOKLET B)

Name: _____ ()

Date : 26 October 2023

Class: P5 _____

Total Time : 1h 45min

INSTRUCTIONS TO CANDIDATES

1. Write your name, class and index number in the spaces provided above.
2. Do not turn over this page until you are told to do so.
3. Follow all instructions carefully.
4. Answer all questions.
5. Use a dark blue or black ballpoint pen to write your answers in the spaces provided for each question.
6. Do not use correction fluid/tape or highlighters.

Score	44
-------	----

29. The following diagrams show two sexual reproductive systems, A and B.

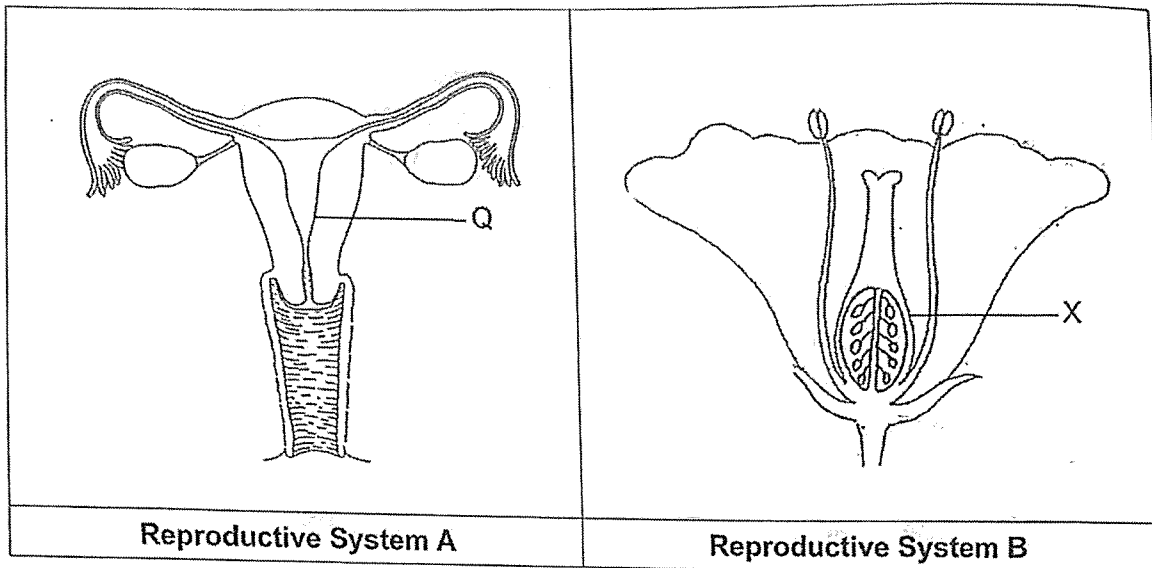

(a) What is the similarity between the function of parts Q and X? [1]

(b) Compare the sexual reproduction process in humans and flowering plants.

(i) State one similarity. [1]

(ii) State one difference. [1]

Score	3
-------	---

30. Observe the flower as shown in the diagram.

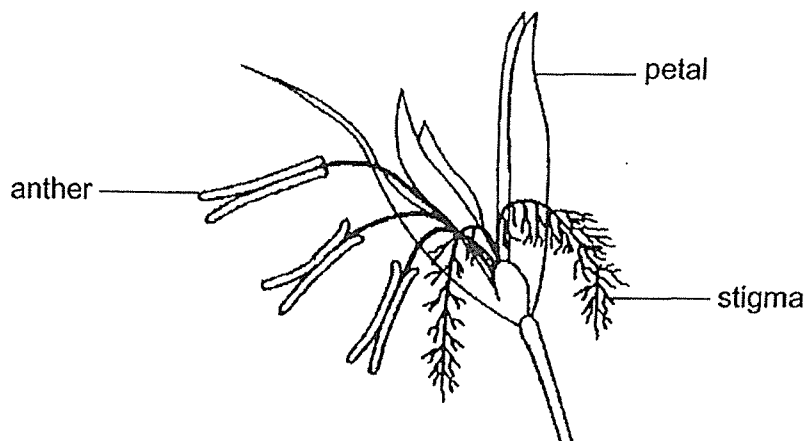

Based on your observations and answer the following questions:

(a) State the method of pollination for the flower. [1]

(b) State two characteristics of the flower that enable it to be pollinated by the method stated in your answer in (a). [2]

(i) _____

(ii) _____

(c) Give a reason why seeds need to be dispersed away from the parent plant. [1]

Score	4
-------	---

31. Beth left three similar pots of plants, E, F and G, in the sun for different duration and watered the plants with the same amount of water daily. The height of each plant was measured and recorded in the table shown after two weeks.

Plant	E	F	G
Duration the plant was placed in the sun daily (hours)	4	6	8
Height of the plant (cm)	7	12	22

- (a) Based on the information above, state the relationship between the duration the plant was placed under the sun daily and the height of the plant. [1]

- (b) Explain how the number of hours the plant was left under the sun each day affects the height of the plant. [2]

Score	3
-------	---

32. The diagram shows how our blood travels in the human body.

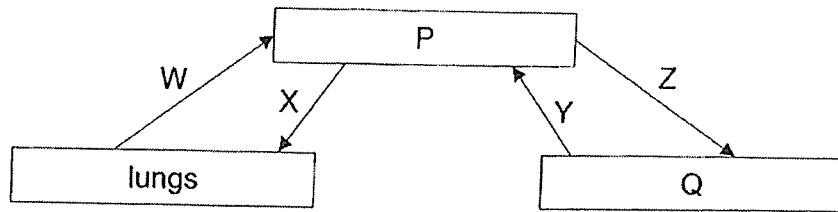

P and Q are organs. Arrows W, X, Y and Z show the movement of blood.

(a) What is organ P? [1]

(b) The bar chart below shows the amount of oxygen in blood samples taken from W, X, Y and Z.

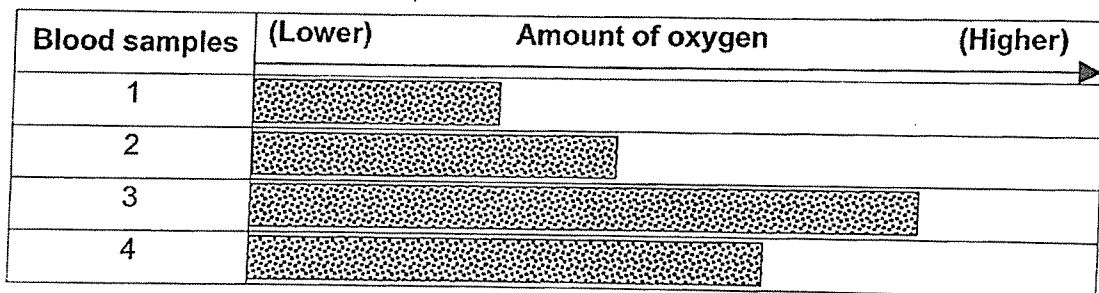

Match the correct movement of blood, W, X, Y or Z, to the blood sample that it was taken from. [1]

Blood samples	Movement of blood
1	E.g. X
2	
3	
4	

(c) Give a reason why the breathing rate increases when a person exercises. [1]

Score	3
-------	---

33. Study the flow chart shown.

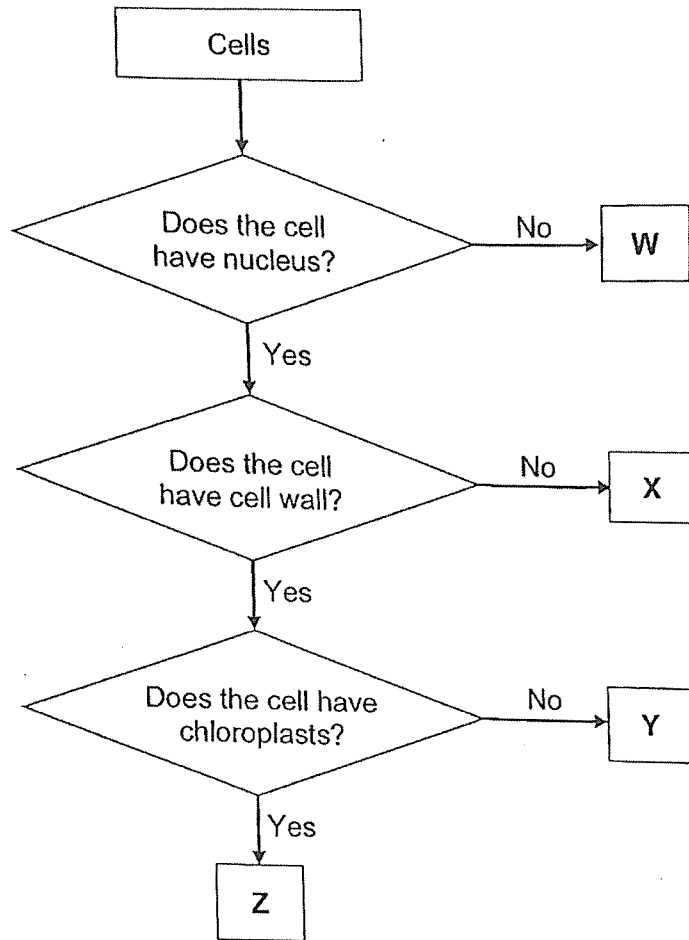

(a) State the similarities between cells Y and Z. [2]

(b) Write 'True' or 'False' in the boxes in the table. [2]

	Conclusion	True / False
(i)	Cell X is from a root cell.	
(ii)	Cell Y is from a plant cell.	
(iii)	Cell Z is found in the leaf of the Angsana tree.	
(iv)	Cells W, X, Y and Z carry out cell division.	

Score	4
-------	---

34. Karen wanted to make a model of the human respiratory system. The diagrams show the materials that she used.

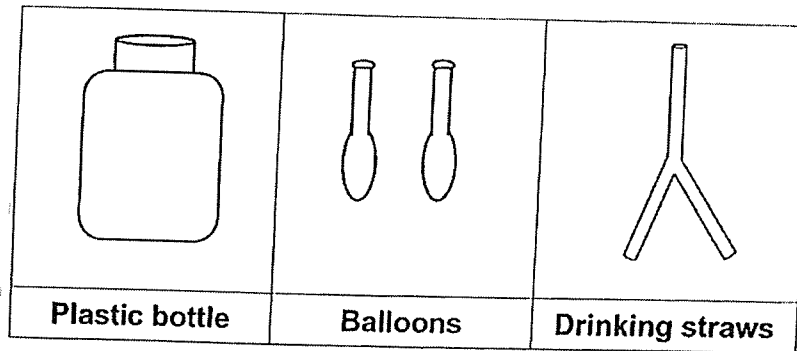

- (a) Name the parts of the respiratory system that matches with materials above. [1]

Materials	Parts of the respiratory system
Balloons	
Drinking straws	

- (b) Which part of the skeletal system does the plastic bottle represent and how does it help the respiratory system? [2]

Score	3
-------	---

P5 Science EYE 2023

35. Jack kept some organisms in a container.

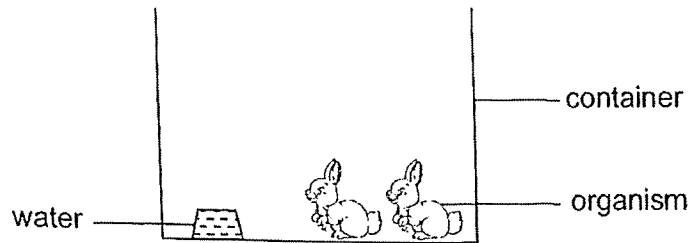

(a) State the differences between the inhaled and exhaled air of the organisms. [2]

Inhaled air	Exhaled air
E.g. Contains more oxygen	Contains less oxygen
(i)	
(ii)	

Jack conducted an experiment to find out the changes in the amount of oxygen in a container with the organisms inside after one hour. He placed a gauze with small holes on top of the container as shown in the diagram.

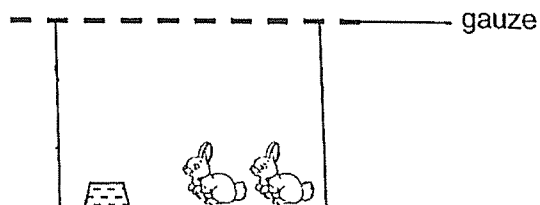

(b) He noticed the amount of oxygen in the container remained the same after one hour. Explain why. [1]

Score	3
-------	---

36. The diagram shows how substances are transported in a plant.

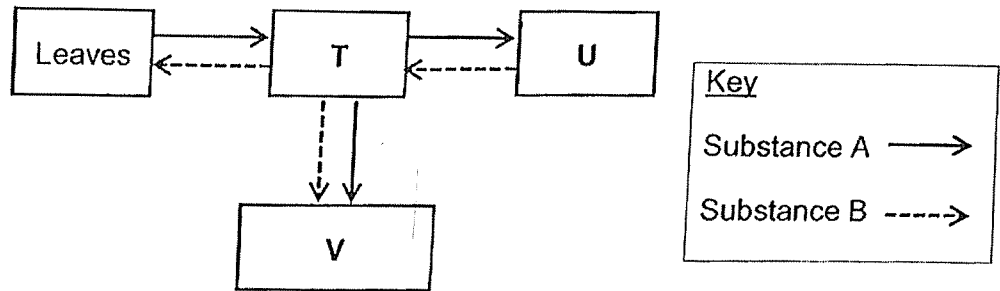

(a) Identify substances A and B. [1]

Substance A : _____

Substance B : _____

The diagram shows a plant.

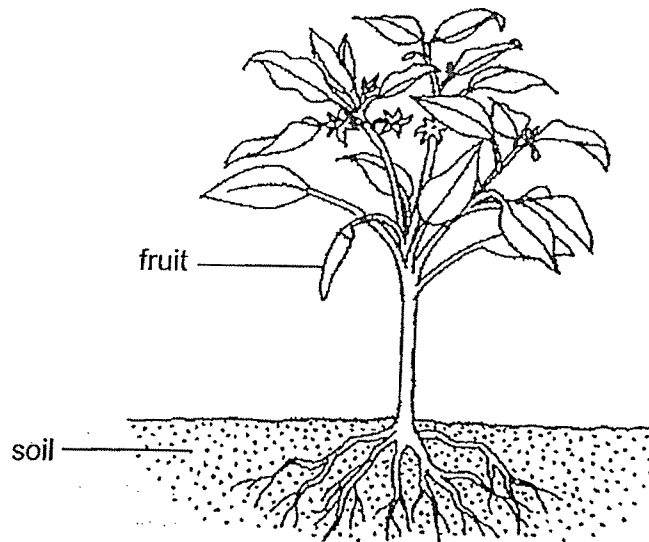

(b) Describe how water is transported to the fruit. [2]

Score	3
-------	---

37. The diagram shows part of the trunk of a small tree with the outer ring of bark, which contained the food-carrying tubes, removed.

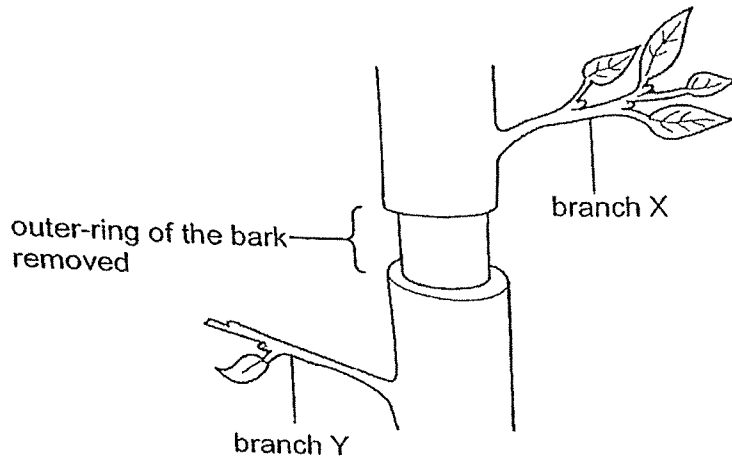

- (a) What effect will removing the outer ring of the bark have on branches X and Y after some time?
Put a tick (✓) in the correct boxes. [1]

Branch	Thickness of branches		Colour of leaves	
	Increased	Decreased	Green	Brown
X				
Y				

- (b) Explain your answer in (a) about the thickness of branch Y. [2]

Score	3
-------	---

38. The following statements describe the events that take place in the water cycle.

- A Water vapour condenses.
- B Water droplet form clouds.
- C Water evaporates and rises into the atmosphere.
- D Warmth from the Sun heats up the water bodies on Earth.
- E Water droplets fall as rain and is collected in rivers and lakes.

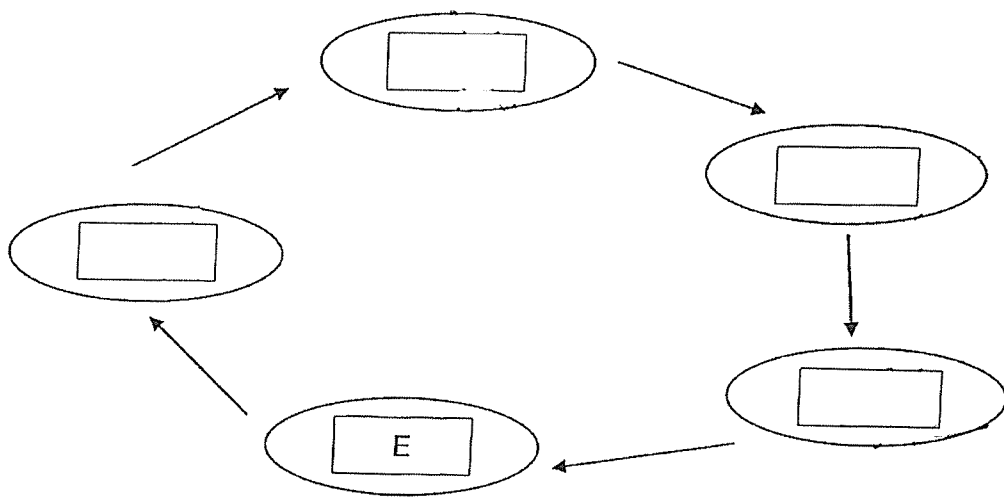

(a) Write the letters, A, B, C and D, in the boxes above to describe the water cycle in the correct order. [1]

Continue on page 34

Score	1
-------	---

Continued from page 33

John created a set-up that is able to obtain pure water from seawater for drinking.

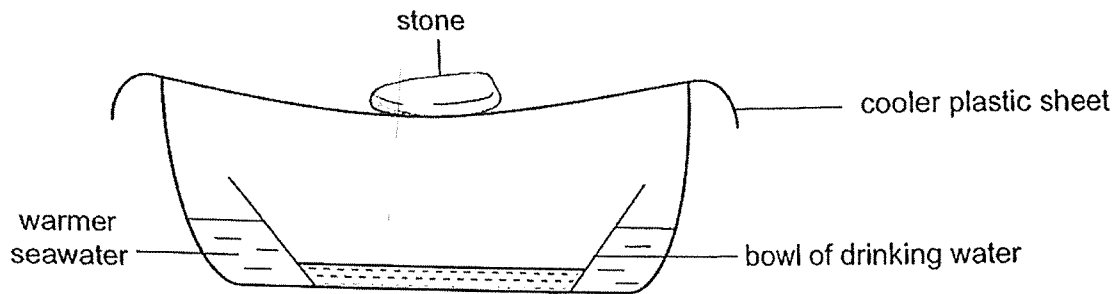

- (b) Explain how the above set-up enable John to collect drinking water from the seawater. [2]

- (c) Suggest what John can do to collect more of drinking water within a shorter period of time. Explain your answer clearly. [2]

Score	4
-------	---

39. Helen wanted to use hot stones, heated to 200°C , to boil water. She placed some hot stones in a wooden container filled with water as shown in the diagram.

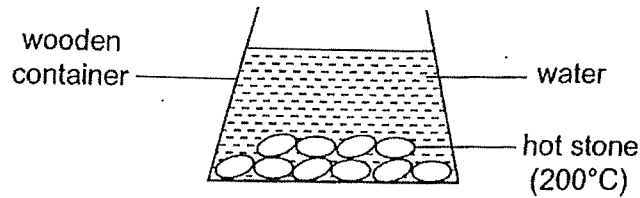

- (a) Explain why the water boils faster when more hot stones are used. [1]

- (b) Helen noticed that when she replaced the wooden container with a metal container, it took a longer time to bring the water to a boil. Explain her observation. [1]

The diagrams below shows two surfaces, X and Y, made of metal.



Surface X

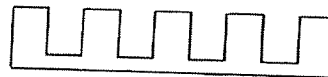

Surface Y

- (c) To cool the water in the wooden container faster, which surface should the container be placed on? Explain your answer. [2]

Score	4
-------	---

40. The diagram shows a toy helicopter with two propellers and a light bulb.

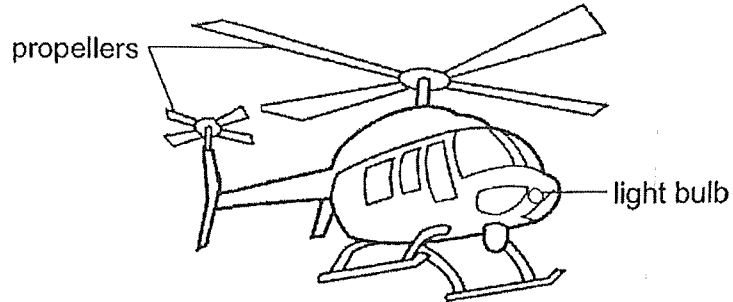

All components in the circuit are in working condition. When the switch is closed, the light bulb does not light up and the propellers did not move.

Kenny opened up the toy to check the electric circuit in the toy as shown.

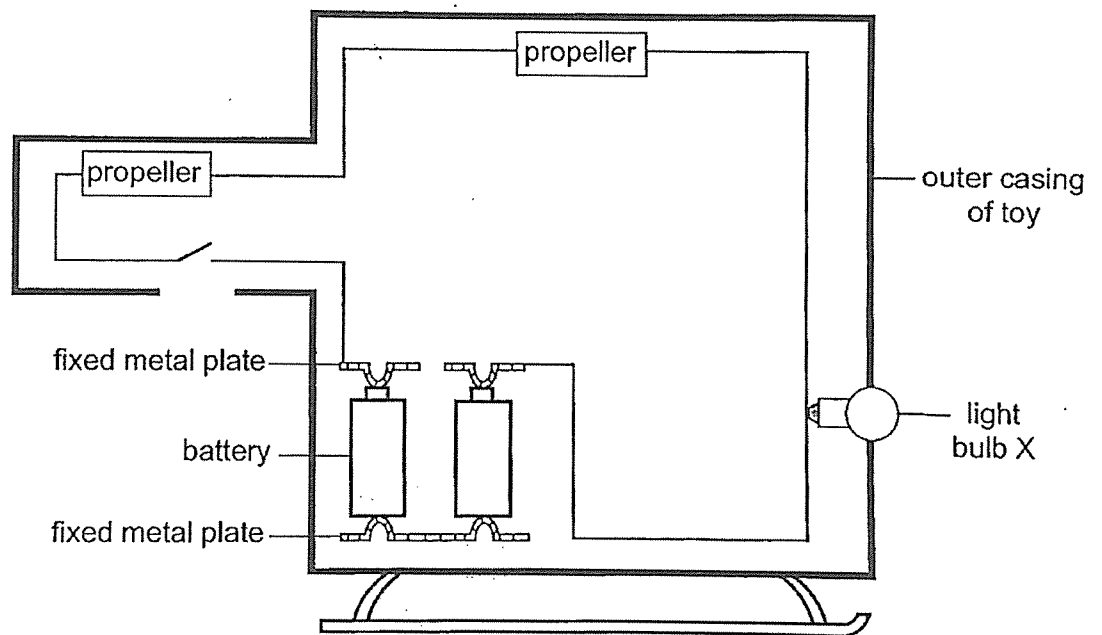

Continue on page 37

Continued from page 36

- (a) Complete the circuit diagram below by drawing the battery and wires correctly. [2]

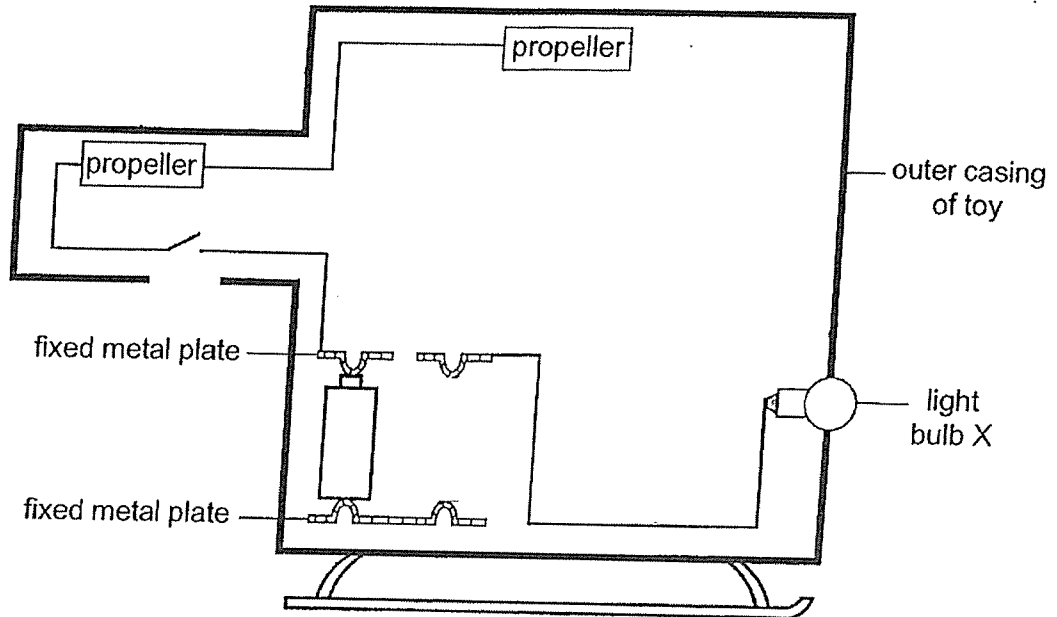

Kenny connected another identical bulb Y in the circuit without dimming bulb X when the switch is closed.

- (b) In the circuit diagram in (a), draw bulb Y correctly. [1]

- (c) Explain why when one propeller is faulty, all the other components could not work. [1]

Score	4
-------	---

41. The diagram below shows a magnet hanging freely from a string at rest.

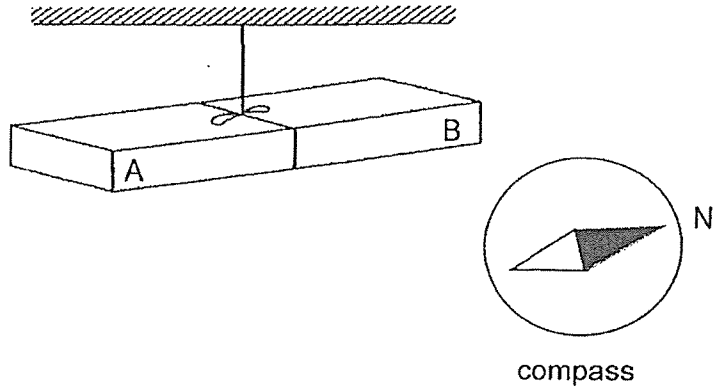

- (a) Which property of magnets is shown above? [1]

Object X was taped onto the top of the plastic toy car as shown.

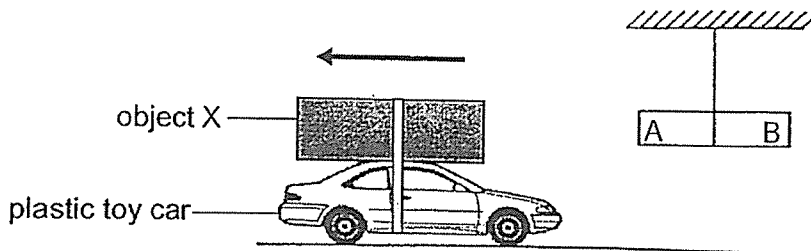

When magnet AB was brought near the toy car, the toy car moved in the direction shown by the arrow in the diagram above.

- (b) Give a reason for the observation of the movement of the toy car. [1]

End of paper

Score	2
-------	---

SCHOOL : RAFFLES GIRLS' PRIMARY SCHOOL
LEVEL : PRIMARY 5
SUBJECT : SCIENCE
TERM : 2023 SA2

CONTACT :

SECTION A

Q1	Q2	Q3	Q4	Q5	Q6	Q7	Q8	Q9	Q10
4	2	2	2	1	3	3	3	4	4
Q11	Q12	Q13	Q14	Q15	Q16	Q17	Q18	Q19	Q20
4	2	4	3	4	3	2	4	4	1
Q21	Q22	Q23	Q24	Q25	Q26	Q27	Q28		
3	3	1	2	3	2	3	3		

SECTION B

Q29a	Q and X are where the fertilised egg develops.
Q29bi	Both the human and flowering plants need the male reproductive cell to fuse with the female reproductive cell in the process of fertilisation.
Q29bii	Humans do not need animals to help them with reproduction while flowering plants need animals to help them with reproduction.
Q30a	Wind pollination
Q30b	(i) Anthers of the flower dangle outside of the flower. (ii) Stigma of the flower protrude outside of the flower.
Q30c	Seeds need to be dispersed further from parent plant to reduce overcrowding, reduce competition between seeds and parent plant for water, mineral salts, space and sunlight, ensuring a healthier growth of seeds.
Q31a	As the duration the plant was placed under the sun daily increases, the height of the plant increases.
Q31b	When the plant was left under the sun for a longer period of time, the leaves would be able to trap more sunlight. This allows the plant to photosynthesise more, to make more food for the plant. Hence, plants that are left in the sun for longer would grow taller in height.
Q32a	Heart
Q32b	Blood sample 2: Y Blood sample 3: W Blood sample 4: Z

Q32c	During exercise, the person needs more energy. Thus, the person's breathing rate increases to take in more oxygen and breathe out more carbon dioxide in the process of gaseous exchange at a faster rate to release more energy and carbon dioxide.
Q33a	Both Y and Z have a cell wall and a nucleus.
Q33b	(i) False (ii) True (iii) True (iv) False
Q34a	Balloons: Lungs Drinking straws: Windpipe
Q34b	The plastic bottle represents the ribcage. The ribcage protects the vital organs such as the heart and lungs preventing the vital organs from being damaged easily.
Q35ai	Inhaled air: contains less carbon dioxide Exhaled air: contains more carbon dioxide
Q35aii	Inhaled air: contains less water vapour Exhaled air: contains more water vapour
Q35b	Amount of oxygen will remain the same as the oxygen that the organism takes in for respiration will be replaced by the oxygen that enters through the holes in the gauze.
Q36a	Substance A: Food Substance B: Water
Q36b	The roots absorb water and mineral salts from the soil. The water in the water-carrying tubes is transported up through the stem to the fruit.
Q37a	Branch X: thickness increase; colour green Branch Y: thickness decrease; colour green
Q37b	The food-carrying tube above the branch Y was removed. Hence, less food will be transported to the branch Y from X than before, slowing down the growth of the branch.
Q38a	$E \rightarrow D \rightarrow C \rightarrow A \rightarrow B$
Q38b	The cooler water in the seawater gained heat from the warmer surrounding air to evaporate and form water vapour. The warmer water vapour rises, comes into contact with the cooler underside of the plastic sheet to condense and form water droplets. When enough water droplets accumulate on the plastic sheet, the water droplets would become heavy enough to drip into the bowl.
Q38c	John should change the bowl of drinking water to a narrower bowl. There would be a larger exposed surface area in contact with the warmer surrounding air and the warmer water in the seawater can evaporate faster to form more water vapour.
Q39a	As the hot stones contain heat, the cooler water would gain heat faster from the warm hot stones.

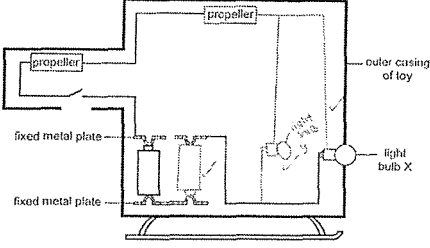
Q39b	Wood is a poorer conductor of heat than metal. The cooler metal container gained heat faster from the warmer water. The warmer metal container came into contact with the cooler surrounding air and lost heat to the cooler surround air.
Q39c	Surface X. X has a larger surface area in contact with the container. Thus surface X will conduct heat away from the container at a faster rate.
Q40a& b	
Q40c	When one propeller is faulty, the circuit becomes an open circuit. Thus electric current cannot flow.
Q41a	When a magnet is hung freely, the magnet would always come to rest in the North-South direction.
Q41b	Object X is a magnet because the like poles of both magnets are facing each other, causing them to repel each other and the toy car would move back.