



MARIS STELLA HIGH SCHOOL (PRIMARY)
END-YEAR EXAMINATION
PRIMARY 5 MATHEMATICS
26 OCTOBER 2023
PAPER 1
(BOOKLET A)

15 questions

20 marks

Total Time for Booklets A and B: 1 hour

NAME : _____ ()

CLASS : PRIMARY 5 _____

INSTRUCTIONS TO CANDIDATES

1. DO NOT OPEN THIS BOOKLET UNTIL YOU ARE TOLD TO DO SO.
2. FOLLOW ALL INSTRUCTIONS CAREFULLY.
3. ANSWER ALL QUESTIONS.
4. SHADE YOUR ANSWERS IN THE OPTICAL ANSWER SHEET (OAS) PROVIDED.
5. YOU ARE **NOT** ALLOWED TO USE A CALCULATOR.

Questions 1 to 10 carry 1 mark each. Questions 11 to 15 carry 2 marks each. For each question, four options are given. One of them is the correct answer. Make your choice (1, 2, 3 or 4) and shade your answer on the Optical Answer Sheet. (20 marks)

1 $70\,000 + 9000 + 200 + 5 =$ _____

- (1) 70 925
- (2) 79 025
- (3) 79 205
- (4) 79 250

2 The digit 4 in 458 321 is in the _____ place.

- (1) hundreds
- (2) thousands
- (3) ten thousands
- (4) hundred thousands

3 Arrange these fractions from greatest to smallest.

$$\frac{7}{6}, \frac{4}{3}, 1\frac{1}{2}$$

 Greatest Smallest

- (1) $\frac{7}{6}, \frac{4}{3}, 1\frac{1}{2}$
- (2) $\frac{4}{3}, \frac{7}{6}, 1\frac{1}{2}$
- (3) $1\frac{1}{2}, \frac{4}{3}, \frac{7}{6}$
- (4) $1\frac{1}{2}, \frac{7}{6}, \frac{4}{3}$

4 Which of the following is likely to be the mass of a pear?

- (1) 12 g
- (2) 120 g
- (3) 1200 g
- (4) 12 000 g



5 Which decimal is greater than 0.08 but smaller than 0.17?

- (1) 0.01
- (2) 0.10
- (3) 0.18
- (4) 0.90

6 In the scale below, what is the value of A?

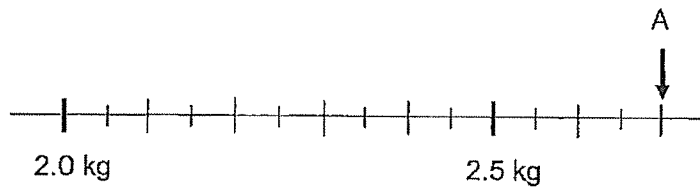

- (1) 2.70 kg
- (2) 2.75 kg
- (3) 2.90 kg
- (4) 3.00 kg

7 A solid cuboid has a height of 8 cm and a square base of sides 5 cm. Find its volume.

- (1) 40 cm³
- (2) 200 cm³
- (3) 240 cm³
- (4) 320 cm³

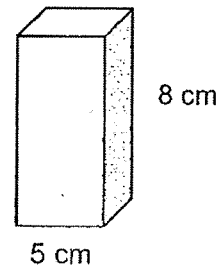

8 A machine takes 2 min to print 6 posters. At the same rate, how long will it take to print 48 posters?

- (1) 8 min
- (2) 12 min
- (3) 16 min
- (4) 24 min

9 In the figure below, AB and CD are straight lines.

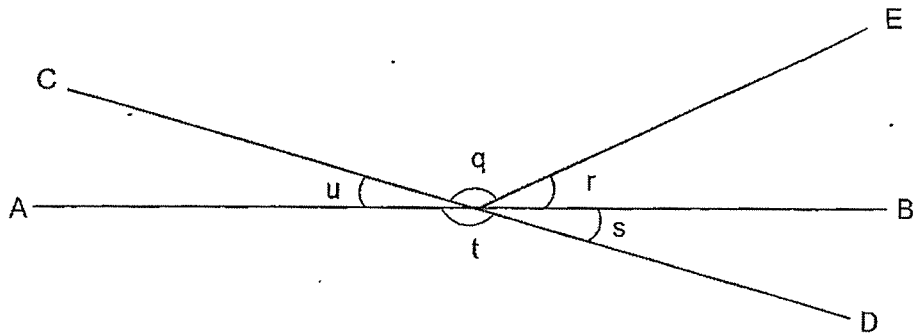

Which of the following is true?

- (1) $\angle r = \angle u$
- (2) $\angle q + \angle r = 180^\circ$
- (3) $\angle q + \angle r + \angle s = 180^\circ$
- (4) $\angle q + \angle r + \angle s + \angle t = 360^\circ$

10 Round off 87 954 to the nearest thousand.

- (1) 80 000
- (2) 87 000
- (3) 88 000
- (4) 90 000

- 11 The heights of four boys are given in the table below.

Name	Height
Ali	1.6 m
Bala	1 m 32 cm
Chenle	145 cm
Danial	$1\frac{1}{2}$ m

Who is the tallest?

- (1) Ali
 - (2) Bala
 - (3) Chenle
 - (4) Danial
- 12 There are 24 yellow balloons and 56 purple balloons. What is the ratio of the number of purple to yellow balloons?
- (1) 3 : 7
 - (2) 7 : 3
 - (3) 3 : 10
 - (4) 7 : 10
- 13 Which one of the following is the greatest in value?
- (1) $32 \div 100$
 - (2) $32 \div 1000$
 - (3) $320 \div 100$
 - (4) $320 \div 1000$

14 $\frac{2}{3}$ of a number is 12. What is $\frac{1}{2}$ of the number?

- (1) 8
- (2) 9
- (3) 18
- (4) 4

15 What is the least number of cubes to be added to the solid figure below to form a cuboid?

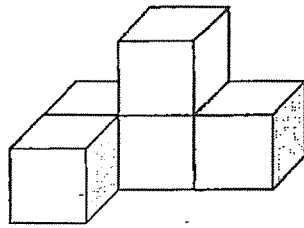

- (1) 5
- (2) 7
- (3) 12
- (4) 22

End of Booklet A
Go on to Booklet B



MARIS STELLA HIGH SCHOOL (PRIMARY)
END-YEAR EXAMINATION
PRIMARY 5 MATHEMATICS
26 OCTOBER 2023
PAPER 1
(BOOKLET-B)

15 questions

25 marks

Total Time for Booklets A and B: 1 hour

NAME : _____ ()
CLASS : PRIMARY 5 _____

INSTRUCTIONS TO CANDIDATES

1. DO NOT OPEN THIS BOOKLET UNTIL YOU ARE TOLD TO DO SO.
2. FOLLOW ALL INSTRUCTIONS CAREFULLY.
3. ANSWER ALL QUESTIONS.
4. WRITE YOUR ANSWERS IN THIS BOOKLET.
5. YOU ARE **NOT** ALLOWED TO USE A CALCULATOR.

MARKS OBTAINED FOR		
PAPER 1 (BOOKLET A)	/ 20	Parent's Signature: _____
PAPER 1 (BOOKLET B)	/ 25	
TOTAL	/ 45	Date: _____

Questions 16 to 20 carry 1 mark each. Write your answers in the spaces provided.
For questions which require units, give your answers in the units stated. (5 marks)

Do not
write in
this
space.

16 Find the value of $50 - (6 + 8) \div 2 \times 3$.

Answer: _____

17 The capacity of a container is 28 l. It takes 7 min to fill up the tank. What is the rate of water flowing into the tank per minute?

Answer: _____ l / min

18 Find the largest multiple of 8 that is smaller than 60.

8, 16, 24, 32, 40,

Answer: _____

--

19 Find the value of $45 \div 200$. Express your answer as a fraction in its simplest form.

Do not write in this space.

Answer: _____

20 Express $4\frac{5}{9}$ as a decimal correct to 2 decimal places.

Answer: _____

Questions 21 to 30 carry 2 marks each. Show your workings clearly and write your answers in the spaces provided. For questions which require units, give your answers in the units stated. (20 marks)

Do not write in this space.

- 21 Eric saved \$20 000 in a bank for one year. The bank paid 2% interest rate at the end of each year. How much did he earn as interest at the end of the year?

Answer: \$ _____

- 22 Kala had 40 more chocolates than Jackson at first. Jackson gave 10 of his chocolates to Kala. In the end, Kala has five times as many chocolates as Jackson. How many chocolates did Jackson have in the end?

Answer: _____

--

- 23 ABC is a right-angle triangle. Find the area of triangle ABC.

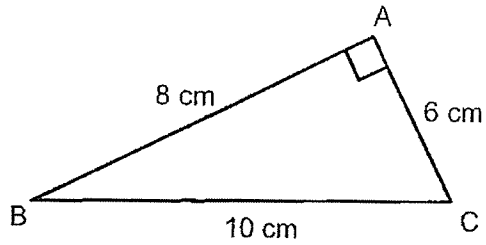

Do not write in this space.

Answer: _____ cm^2

- 24 2 pencils and 4 notebooks cost \$26. 4 pencils and 2 notebooks cost \$22. Find the cost of 1 notebook.

Answer: \$ _____

- 25 Jan drew 3 ovals of different sizes to form a figure below. The areas of the 3 ovals were in the ratio 12 : 10 : 3. She then shaded some parts of the figure as shown. What fraction of the figure was unshaded?

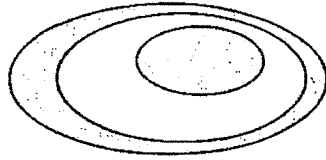

Do not write in this space.

Answer: _____

- 26 The table below show the charges for renting a bicycle at Pasir Ris Park.

First hour	\$6
Every additional 30 min or less	\$2.50

Adam rented a bicycle from 2.00 to 4.50 pm. How much did he pay for the rental?

Answer: \$ _____



27 The figure shows five roads drawn on a map in a square grid.

Do not write in this space.

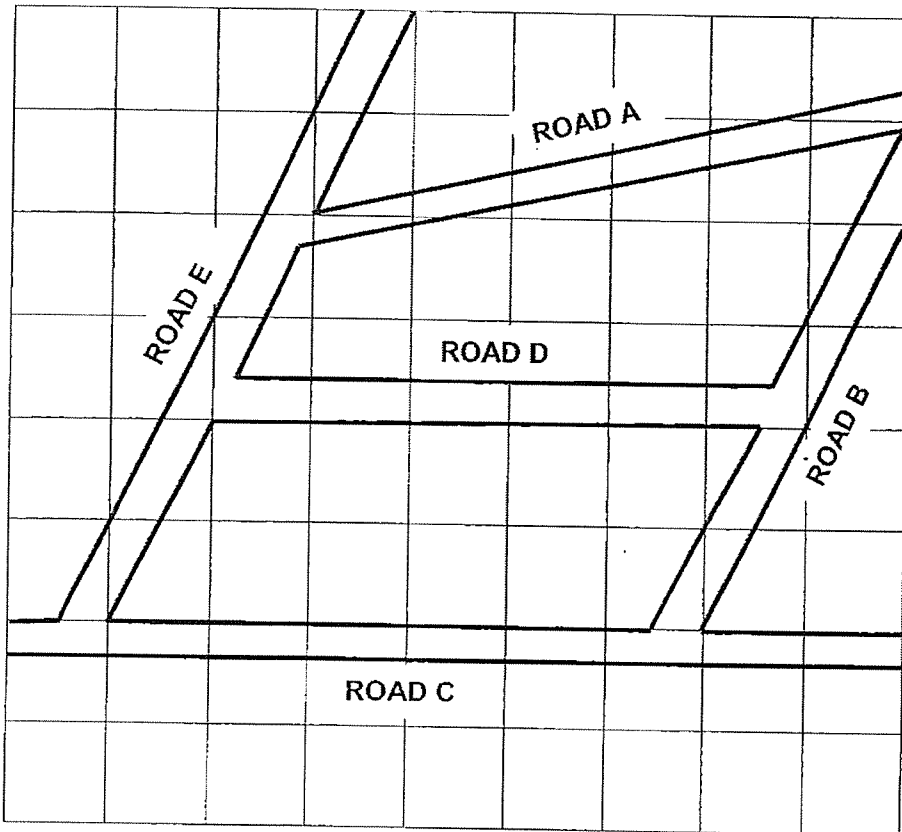

Name the two pairs of roads that are parallel to each other.

Answer: Road _____ and Road _____
Road _____ and Road _____

- 28 The graph below shows the total number of books borrowed from the library from January to April.

Do not write in this space.

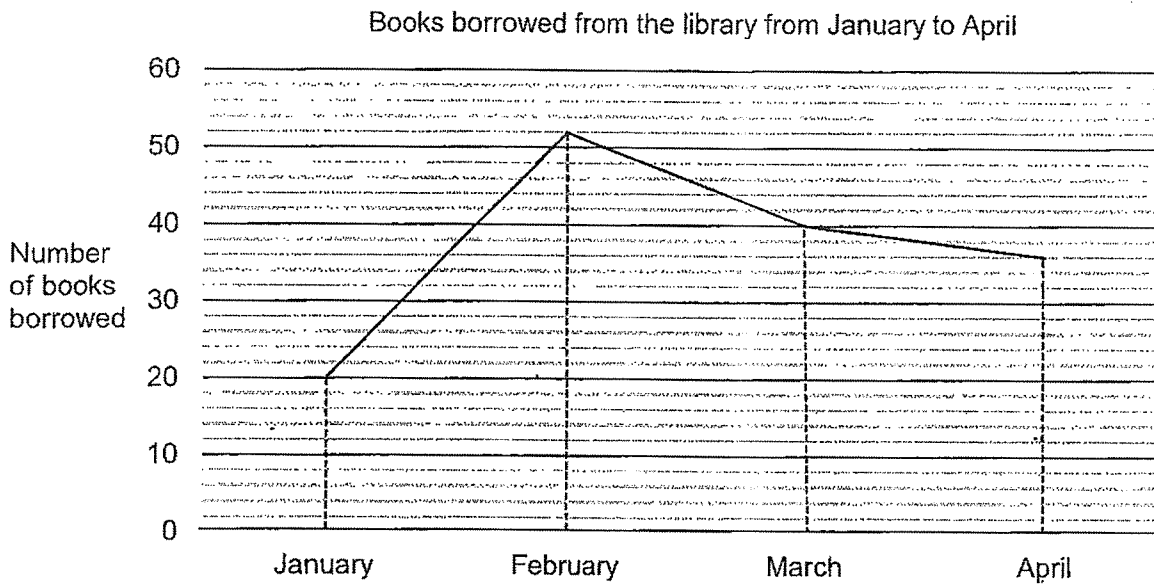

- (a) In which 1-month interval was there an increase in the number of books borrowed?
- (b) There were _____ more books borrowed in March than April.

Answer: (a) _____ and _____ [1]

(b) _____ [1]

- 29 AB is one side of rhombus ABCD.
 a) Use a pencil to complete the drawing of rhombus ABCD.
 Label points C and D clearly.
 b) Measure $\angle BAD$.

[1m]
 [1m]

Do not
 write in
 this
 space.

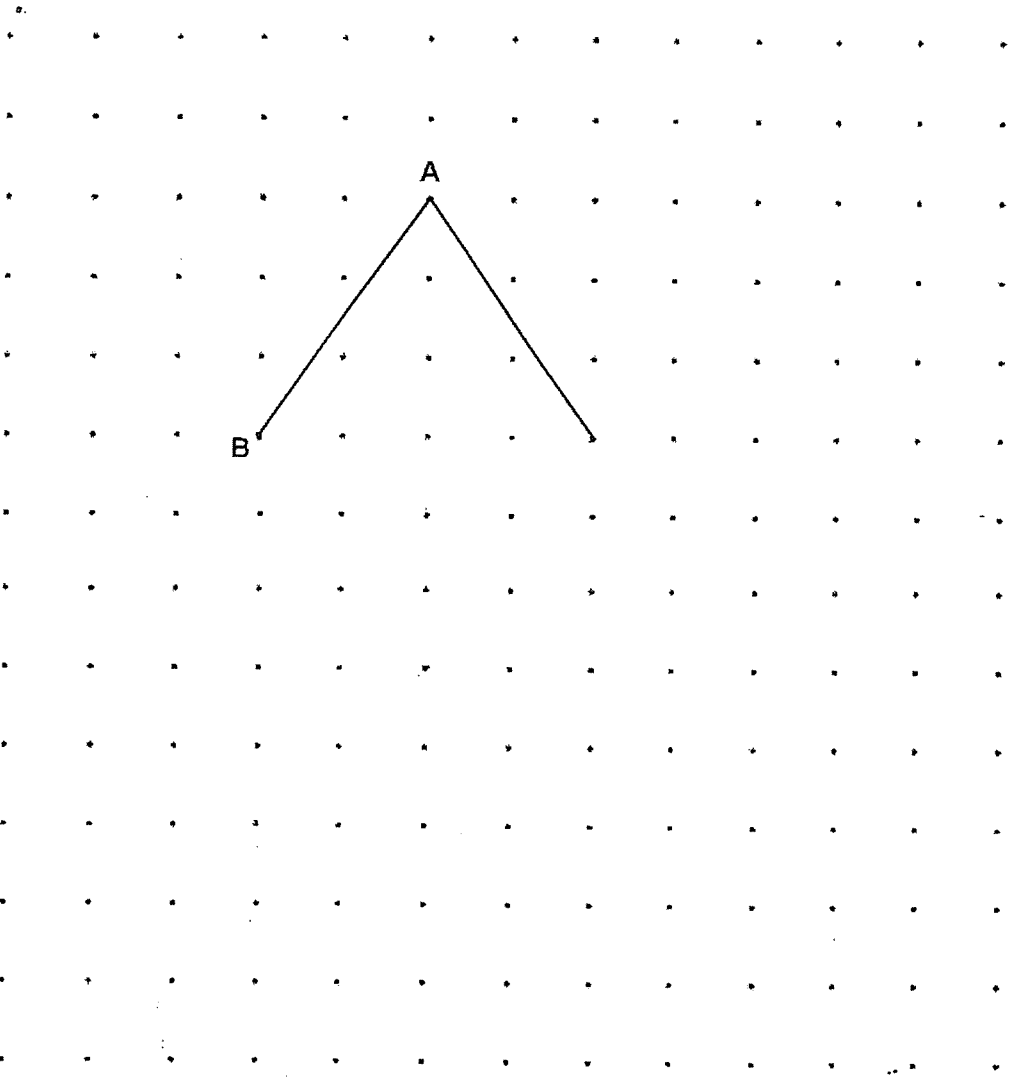

Answer: (a) _____°

--

- 30 In the figure below, a rectangular piece of paper is folded along a straight line EF. Find $\angle AFB$.

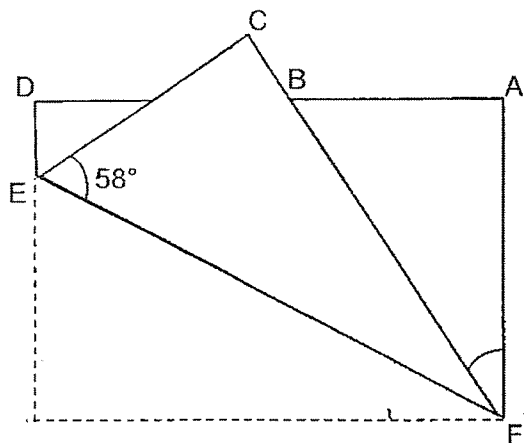

Do not write in this space.

Answer: _____^o



MARIS STELLA HIGH SCHOOL (PRIMARY)
END-YEAR EXAMINATION
PRIMARY 5 MATHEMATICS
26 OCTOBER 2023
PAPER 2

17 questions

55 marks

Time: 1 h 30 min

NAME : _____ ()

CLASS : PRIMARY 5 _____

INSTRUCTIONS TO CANDIDATES

1. DO NOT OPEN THIS BOOKLET UNTIL YOU ARE TOLD TO DO SO.
2. FOLLOW ALL INSTRUCTIONS CAREFULLY.
3. ANSWER ALL QUESTIONS.
4. SHOW YOUR WORKINGS CLEARLY AS MARKS ARE AWARDED FOR CORRECT WORKING.
5. WRITE YOUR ANSWERS IN THIS BOOKLET.
6. YOU ARE ALLOWED TO USE A CALCULATOR.

MARKS OBTAINED FOR		
PAPER 1 (BOOKLET A & B)	/ 45	Parent's Signature: _____ Date: _____
PAPER 2	/ 55	
TOTAL	/100	

Questions 1 to 5 carry 2 marks each. Show your working clearly in the space provided for each question and write your answers in the spaces provided. (10 marks)

Do not write in this space.

1 What fraction of the rectangles below are shaded?

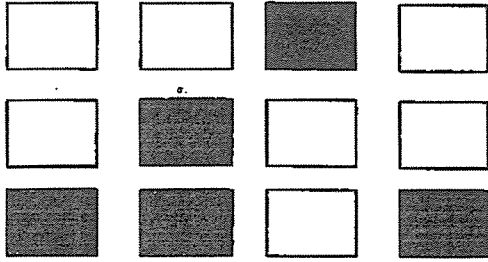

Answer: _____

2 In the figure below, VZY is a straight line. Find the value of $\angle a$.

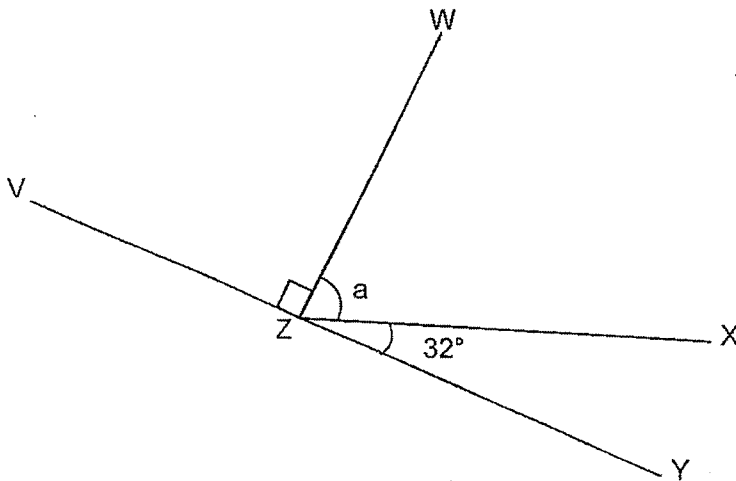

Answer: _____°

- 3 The rectangular tank below is $\frac{3}{5}$ filled with water. How much more water is needed to fill the rectangular tank to the brim?

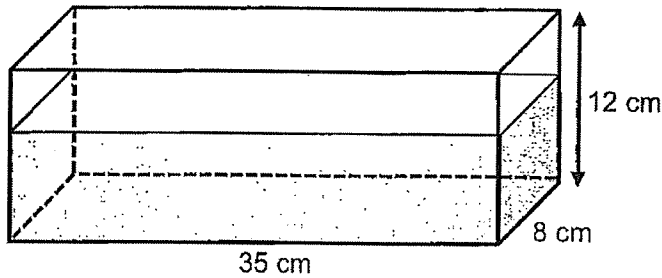

Do not write in this space.

Answer: _____ ml

- 4 WXYZ is a trapezium and $WZ = WX$.

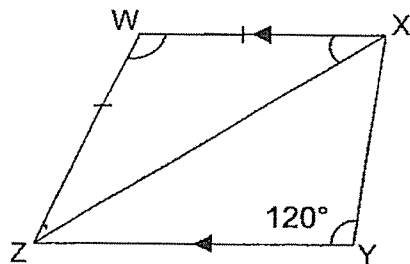

Each statement below is either *true*, *false* or *not possible to tell* from the information given. For each statement, put a tick (\checkmark) in the correct column.

Statement	True	False	Not possible to tell
a) $\angle XWZ + \angle WZY = 180^\circ$			
b) $\angle WXZ = 30^\circ$			

- 5 The figure below shows a rectangle that has been cut into 4 triangles, W, X, Y and Z. Find the area of triangle Y.

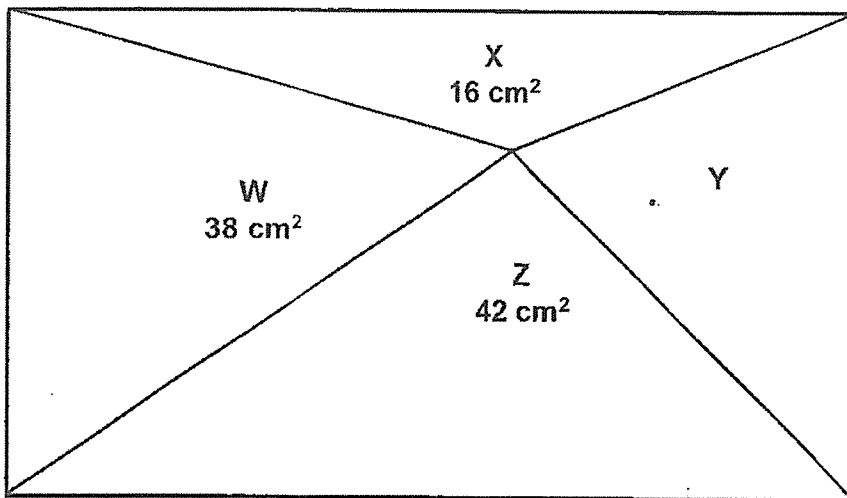

Do not write in this space.

Answer: _____ cm^2

For questions 6 to 17, show your workings clearly and write your answer in the spaces provided. The number of marks available is shown in the brackets [] at the end of each question or part-question. (45 marks)

Do not write in this space.

- 6 A baker had some flour. After he used $4\frac{3}{5}$ kg of flour to bake a cake, he bought another $2\frac{1}{2}$ kg of flour. He had 9 kg of flour now. How much flour did he have at first?

Answer: _____ [3]

- 7 In a carpark, there are cars and bicycles. There are 24 more cars than bicycles. There are 276 wheels altogether in that carpark. How many bicycles are there altogether?

Answer: _____ [3]

8 Container A contained 1.05 kg of rice. Container B contained 3.09 kg of rice. After an equal amount of rice was removed from each container, Container B now has 4 times as much rice as Container A. How much rice was removed from each container? Give your answer in kilograms.

Do not write in this space.

Answer: _____ [3]

9 The average mass of 6 boys in a room was 52 kg. When 2 boys left the room, the average mass of the boys left was 48 kg. What was the average mass of the 2 boys who left the room?

Answer: _____ [3]

- 10 Sheena was given \$8 as pocket money each day. On Mondays to Fridays, she spent \$5.60 every day and saved the rest. She did not spend any money on the weekends and saved her pocket money. Sheena started saving on Monday. How many days would it take for Sheena to save \$35.20?

Do not
write in
this
space.

Answer: _____ [3]

- 11 80 students were asked to choose one sport – basketball, badminton or table tennis. The graph below shows the number of students who chose each sport. The number of students is not shown on the scale.

Do not write in this space.

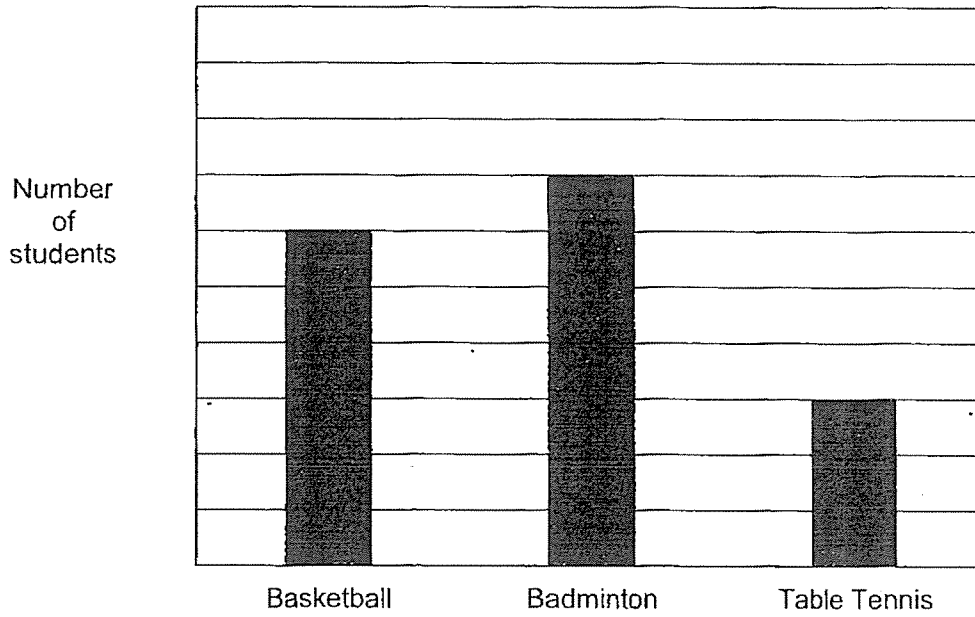

- (a) A total of _____ students chose Badminton and Table Tennis.
(b) _____ % of the students chose Basketball

Answer: (a) _____ [2]

(b) _____ [1]

- 12 The ratio of the number of apples to mangoes sold by Shop A is 4 : 3. The ratio of the number of apples to mangoes sold by Shop B is 3 : 2. Shop A and B sold an equal number of mangoes. 70 more apples were sold in Shop B than in Shop A. How many apples and mangoes were sold in total in Shop B?

Answer: _____ [4]

- 13 The figure below is not drawn to scale. It is made up of rhombus CDEF and triangles CGF and ABG. $AB = BG$. Find
 (a) $\angle ABG$
 (b) $\angle BCH$

Do not write in this space.

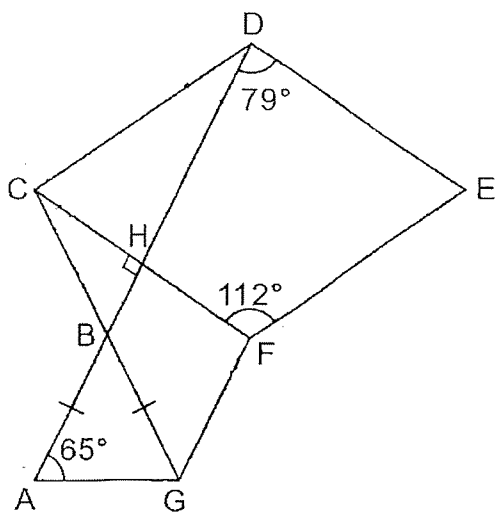

Answer: (a) _____ [1]

(b) _____ [3]

- 14 The brochure below shows the details on a sale in Shop A.

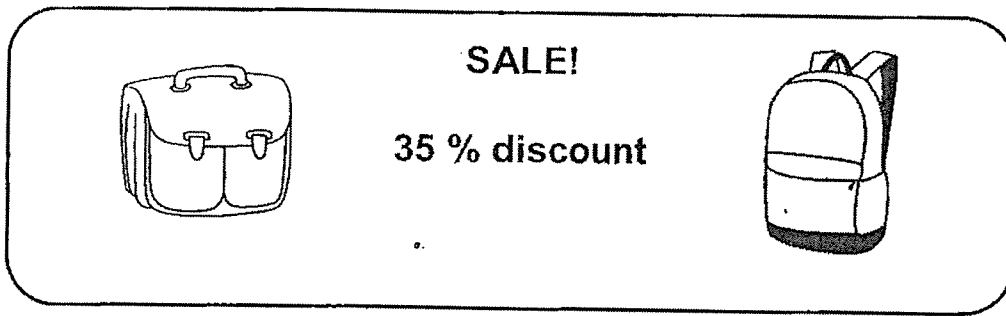

Do not
write in
this
space.

- (a) Anita bought 2 of the same leather bags during a sale in Shop A. The usual price of the leather bag was \$450. Find the amount of discount she received for both bags.
- (b) Meili bought a backpack at the sale. The usual price of the backpack was 40% of the usual price of the leather bag. What was the discounted price of the backpack?

Answer: (a) _____ [2]

(b) _____ [2]



15 Siti's mother gave her some money. Siti had just enough money to buy 68 files at the usual price. During a sale, Siti was given a discount of \$3.40 for each file. As a result, she was able to buy 19 more files and had \$3.20 left.

- (a) What was the price of one file during the sale?
- (b) How much did Siti's mother give her?

Do not write in this space.

Answer: (a) _____ [3]

(b) _____ [2]

--

- 16 Ali and Betty had a total of \$5700. After Ali spent $\frac{1}{3}$ of his money and Betty spent $\frac{2}{5}$ of her money, they had an equal amount left. Betty then used $\frac{3}{4}$ of the amount she had left to buy a laptop and gave the remaining amount to her sister and brother. Betty's brother received 3 times the amount that Betty's sister received.
- a) How much did Betty have at first?
 - b) How much did Betty's sister receive?

Do not write in this space.

Answer: (a) _____ [2]

(b) _____ [3]

--

- 17 The area of triangle PRQ is 16 cm^2 . QRST is a square. WQUV is a rectangle and ZRS and ZTU are right-angle triangles. $WQ = QR$, $ZS = 5 \text{ cm}$ and $WV = 17 \text{ cm}$.
- What is the length of RQ?
 - Find the total area of the figure below.

Do not write in this space.

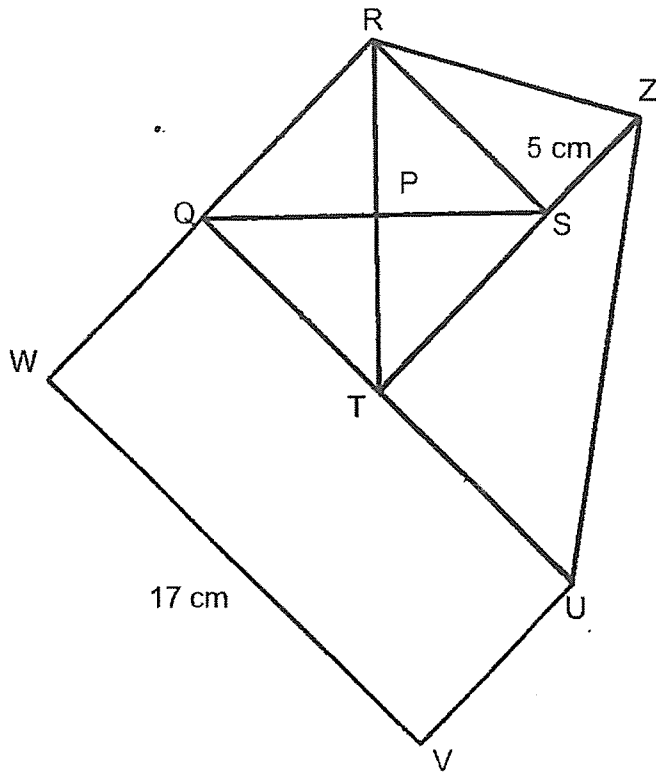

Answer: (a) _____ [1]
 (b) _____ [4]

End of Paper 2



SCHOOL : MARIS STELLA HIGH SCHOOL
LEVEL : PRIMARY 5
SUBJECT : MATHEMATICS
TERM : 2023 SA2

PAPER 1 (BOOKLET A)

Q1	3	Q2	4	Q3	3	Q4	2	Q5	2
Q6	1	Q7	2	Q8	3	Q9	3	Q10	3
Q11	1	Q12	2	Q13	3	Q14	2	Q15	2

PAPER 1 (BOOKLET B)

Q16	29
Q17	4 l / min
Q18	56
Q19	$\frac{9}{40}$
Q20	4.56
Q21	$\frac{2}{100} \times \$20000 = \400
Q22	$4u = 60$ $1u = 15$
Q23	24 cm²
Q24	$2P + 4N = \$26$ $4P + 2N = \$22$ Make P the same by multiplying 2 to the first statement: $4P + 8N = \$52$ Difference: $8N - 2N = 6N$ $6N = \$52 - \$22 = \$30$ $1N = \$5$
Q25	Total area = 12u Unshaded area = $10u - 3u = 7u$ Fraction unshaded = $\frac{7}{12}$
Q26	\$16
Q27	Road C and Road D; Road B and Road E
Q28a	January and February

Q28b	4
Q29a	
Q29b	70°
Q30	$\angle CFE = 180^\circ - 58^\circ - 90^\circ = 32^\circ$ $\angle AFB = 90^\circ - 32^\circ - 32^\circ = 26^\circ$

PAPER 2

Q1	$\frac{5}{12}$
Q2	58°
Q3	$\frac{2}{5} \times 12 \times 8 \times 35 = 1344 \text{ ml}$
Q4a	True
Q4b	False
Q5	$42 \div 3 = 12 \text{ cm}^2$ $16 \div 2 = 8 \text{ cm}^2$ Area of Y = $12 + 8 = 20 \text{ cm}^2$
Q6	$9 - 2\frac{1}{3} = 6\frac{1}{2} \text{ kg}$ $6\frac{1}{2} + 4\frac{3}{5} = 11\frac{1}{10} \text{ kg}$
Q7	$24 \times 4 = 96$ $276 - 96 = 180$ Group 1 car and 1 bicycle as a set: total 6 wheels $180 \div 6 = 30$
Q8	$3u = 3.09 - 1.05 = 2.04 \text{ kg}$ $1u = 0.68 \text{ kg}$ Removed = $1.05 - 0.68 = 0.37 \text{ kg}$
Q9	Average mass of 6 boys = $6 \times 52 = 312 \text{ kg}$ Average mass of 4 boys = $4 \times 48 = 192 \text{ kg}$ Average mass of the 2 boys = $(312 - 192) \div 2 = 60 \text{ kg}$
Q10	Total pocket money for the week = $\$8 \times 7 = \56 Total saved in a week = $\$56 - \$(5.60 \times 5) = \$28$ $\$35.20 - \$28 = \$7.20$ Amount saved on a weekday = $\$8 - \$5.60 = \$2.40$ $\$7.20 \div \$2.40 = 3$ $3 + 7 = 10 \text{ days}$

Q11a	Total units = 16u 16u = 80 1u = 5 10u = 50								
Q11b	$\frac{30}{80} \times 100\% = 37.50\%$								
Q12	<table style="width: 100%; border: none;"> <tr> <td style="text-align: center;"><u>Shop A</u></td> <td style="text-align: center;"><u>Shop B</u></td> </tr> <tr> <td style="text-align: center;">A : M</td> <td style="text-align: center;">A : M</td> </tr> <tr> <td style="text-align: center;">4 : 3</td> <td style="text-align: center;">3 : 2</td> </tr> <tr> <td style="text-align: center;">8 : 6</td> <td style="text-align: center;">9 : 6</td> </tr> </table> <p style="margin-left: 40px;"> $\left. \begin{array}{l} 4 : 3 \\ 8 : 6 \end{array} \right\} \times 2$ $\left. \begin{array}{l} 3 : 2 \\ 9 : 6 \end{array} \right\} \times$ </p> <p>1u = 70 15u = 70 x 15 = 1050</p>	<u>Shop A</u>	<u>Shop B</u>	A : M	A : M	4 : 3	3 : 2	8 : 6	9 : 6
<u>Shop A</u>	<u>Shop B</u>								
A : M	A : M								
4 : 3	3 : 2								
8 : 6	9 : 6								
Q13a	$\angle ABG = 180^\circ - 65^\circ - 65^\circ = 50^\circ$								
Q13b	$\angle DCF = 180^\circ - 112^\circ = 68^\circ$ $\angle BCH = 180^\circ - 33^\circ - 68^\circ - 50^\circ = 29^\circ$								
Q14a	$\frac{35}{100} \times \$(450 + 450) = \315								
Q14b	Usual price of backpack = $\frac{40}{100} \times \$450 = \180 Discounted price = $\frac{65}{100} \times \$180 = \117								
Q15a	Total discount = $68 \times \$3.40 = \231.20 19F = $\$231.20 - \$3.20 = \$228$ 1F = $\$228 \div 19 = \12								
Q15b	Total files bought = $68 + 19 = 87$ Amount given = $87 \times \$12 + \$3.20 = \$1047.20$								
Q16a	19u = \$5700 1u = \$300 10u = \$3000								
Q16b	Amount Betty had left = $\frac{3}{5} \times \$3000 = \1800 Amount given to siblings = $\$1800 \div 4 = \450 Amount sister received = $\$450 \div 4 = \112.50								
Q17a	Area of QRST = $16 \times 4 = 64 \text{ cm}^2$ Length of RQ = 8cm								
Q17b	Area of $\triangle SRZ = 20 \text{ cm}^2$ Area of $\triangle ZTU = 58.5 \text{ cm}^2$ Area of QUVW = $17 \times 8 = 136 \text{ cm}^2$ Total area = $64 + 20 + 58.5 + 136 = 278.5 \text{ cm}^2$								