

Class Register No.

Candidate Name _____

--	--



**PEIRCE SECONDARY SCHOOL
PRELIMINARY EXAMINATION 2022
SECONDARY 4 EXPRESS**

**PHYSICS
Paper 1 Multiple Choice**

**6091/01
31 Aug 2022
1 hour**

Additional Material:
Multiple Choice Answer Sheet

INSTRUCTIONS TO CANDIDATES

Write in soft pencil.

Do not use paper clips, highlighters, glue or correction fluid.

Write your name, class and register number on the Multiple Choice Answer Sheet in the spaces provided.

There are **forty** questions in this paper. Answer **ALL** questions. For each question there are four possible answers **A, B, C** and **D**.

Choose the **one** you consider correct and record your choice in **soft pencil** on the separate Multiple Choice Answer Sheet.

Read the instructions on the Answer Sheet very carefully.

Each correct answer will score one mark. A mark will not be deducted for a wrong answer.

Any rough working should be done in this paper.

The use of an approved scientific calculator is expected, where appropriate.

This paper consists of **16** printed pages and **0** blank page.
Setter: Mr Kan Cheng Mun

- 1 Which pair consists of two vector quantities?
- A** acceleration and weight **B** density and velocity
C pressure and kinetic energy **D** work done and force
- 2 What is the the micrometer reading in the diagram below?

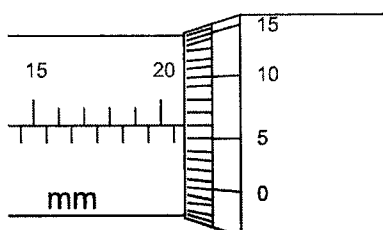

- A** 20.6 mm **B** 20.56 mm **C** 25.06 mm **D** 25.6 mm
- 3 The diagram shows a strip of paper tape that has been pulled under a vibrating arm by an object moving at constant speed. The arm is vibrating regularly, making 50 dots per second.

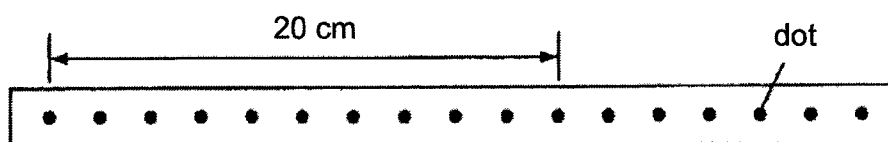

What was the speed of the object?

- A** 2.0 cm/s **B** 5.0 cm/s **C** 100 cm/s **D** 200 cm/s
- 4 Two forces of 15 N and 5 N to the right are applied to a block of mass 5 kg as shown below.

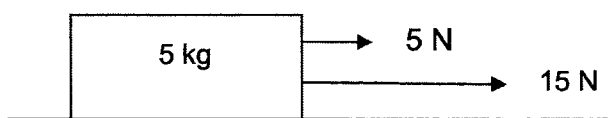

Smooth surface

What is the resultant acceleration?

- A** 3.0 m s⁻² **B** 3.0 m s⁻¹ **C** 4.0 m s⁻² **D** 4.0 m s⁻¹

5 Which of the following **cannot** be the magnitude of the resultant when forces of magnitude 3 N and 4 N are combined?

- A** 1 N **B** 3 N **C** 7 N **D** 8 N

6 An irregular shaped object of copper with density 8.96 g cm^{-3} is lowered into a displacement can filled with water of density 1 g cm^{-3} , until the copper object is completely immersed. The mass of the water which overflowed is 180 g. What is the mass of the copper object?

- A** 20.1 g **B** 180 g **C** 1.61 kg **D** 1.94 kg

7 Two forces of 5 N and 10 N act on a square wooden plane which is pivoted at the centre **O** as shown.

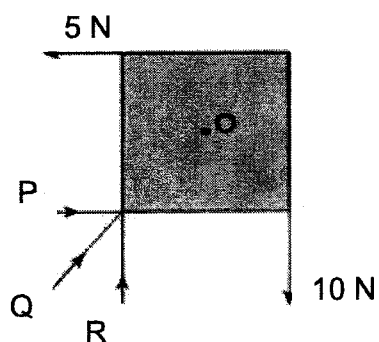

Which of the following conditions can keep the square plane in equilibrium?

	Direction	Force
A	P	5 N
B	P	10 N
C	Q	10 N
D	R	5 N

8 Which shape is the most stable, assuming they have the same mass and height?

A cube

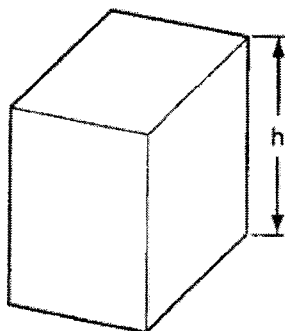

B pyramid

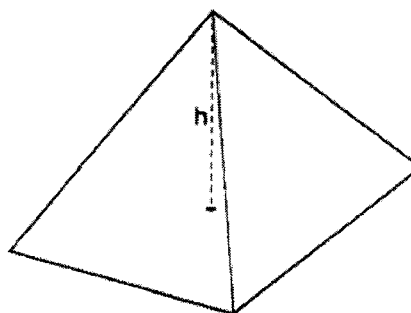

C cylinder

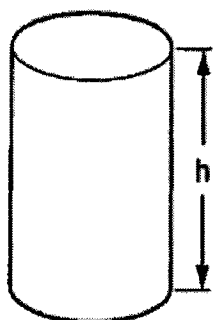

D sphere

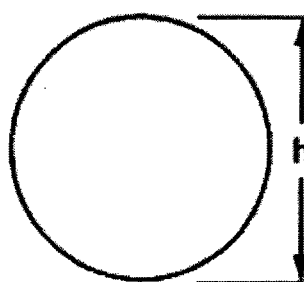

9 Object P has a mass of m and is moving with a speed of v .
Object Q has a mass of $2m$ and is moving with a speed of $\frac{1}{2}v$.

How do the kinetic energies of P and Q compare?

- A The kinetic energy of Q is one half the kinetic energy of P.
- B The kinetic energy of Q is the same as that of P.
- C The kinetic energy of Q is twice the kinetic energy of P.
- D The kinetic energy of Q is four times the kinetic energy of P.

- 10 The gravitational potential energy E_p of a mass varies with height h as shown. The gravitational field strength is 10 N / kg .

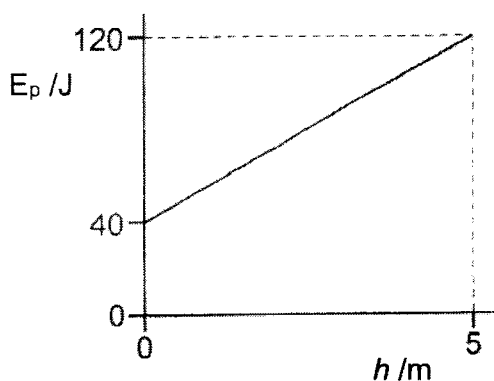

What mass is being lifted?

- A 1.6 kg B 2.4 kg C 8.2 kg D 16 kg
- 11 Which would be the **least** likely to sink into soft ground?
- A A loaded lorry with four wheels. B A loaded lorry with six wheels.
 C An empty lorry with four wheels. D An empty lorry with six wheels.
- 12 The lengths of mercury thread in the stem of a mercury thermometer are given in three situations.
 Length in melting ice = 20 mm
 Length in steam above boiling water = 170 mm
 Length in liquid X = 50 mm

What is the temperature of liquid X?

- A 20 °C B 25 °C C 30 °C D 33.3 °C

- 13 Physical properties of materials are used in the measurement of temperature. Which physical property is **not** suitable for this purpose?

- A expansion of a liquid B mass of a liquid
C resistance of a metal D volume of a liquid

- 14 Smoke particles in a transparent box are observed using a microscope. A small point of light is seen to move around as shown.

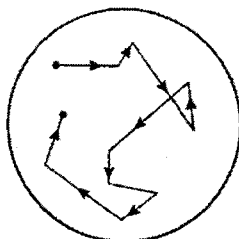

What does this experiment demonstrate about air molecules?

- A They are in continuous random motion.
B They can be seen through a microscope.
C They move more quickly when they are heated.
D They move because of collisions with smoke particles.

- 15 A thin tube contains a thread of mercury which traps air at the end of the tube. The other end of the tube is open to the atmosphere.

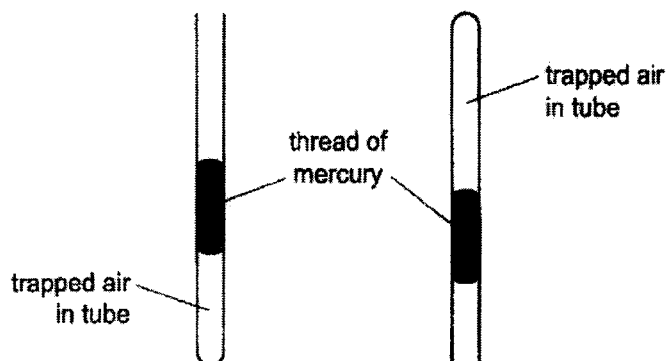

When the tube is turned upside down, the volume of the trapped air increases.

Which statement explains this?

- A The pressure of the trapped air is reduced.
- B The atmosphere pushes less when it acts upwards on the mercury.
- C The air gets hotter when the tube is turned upside down.
- D The trapped air molecules hit the mercury harder when travelling downwards.
- 16 In cold countries, animals usually grow thicker layers of fur in winter to keep them warm. What is the **best** explanation of why this extra fur keeps them warm?
- A It is a good conductor of heat.
- B It is a poor conductor of heat.
- C It traps more air, which is a good conductor of heat.
- D It traps more air, which is a poor conductor of heat.
- 17 In a vacuum flask, which methods of heat transfer are prevented by the vacuum?
- A conduction and convection only
- B convection only
- C conduction only
- D conduction, convection and radiation

- 18 When a lump of ice was added to a beaker of warm water, the resulting water temperature was 5°C less than the initial temperature of the warm water at the instant when all the ice had melted.

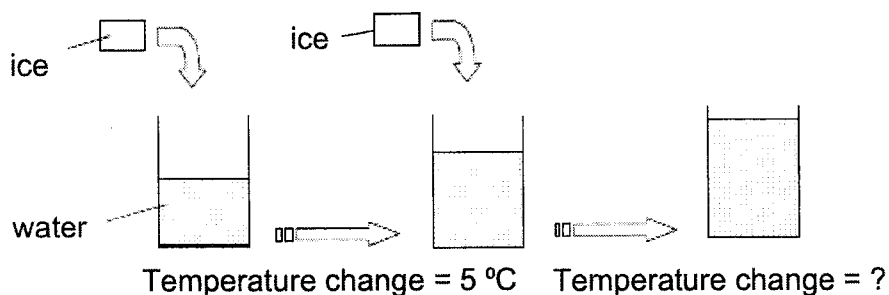

If another identical lump of ice at the same initial temperature is added to the same beaker, the temperature will

- A** decrease by another 5°C **B** will not change at all
C decrease by more than 5°C **D** decrease by less than 5°C
- 19 The diagram shows an object placed in front of a thin converging lens L . If F is the focal point, at which point is the base of the image formed?

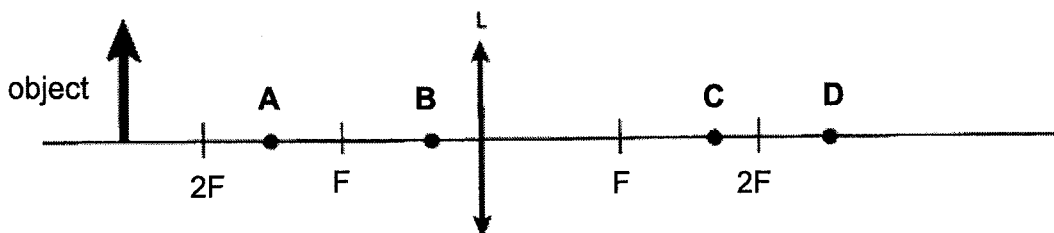

- 20 What is meant by the term wavefront?
- A** a line joining points along the peak of a wave
B a line joining the trough and the peak of a wave
C the distance between successive peaks of a wave
D the distance between the trough and the peak of a wave

- 24 The graph shows how the air pressure varies for a sound wave.
Which point represents a compression?

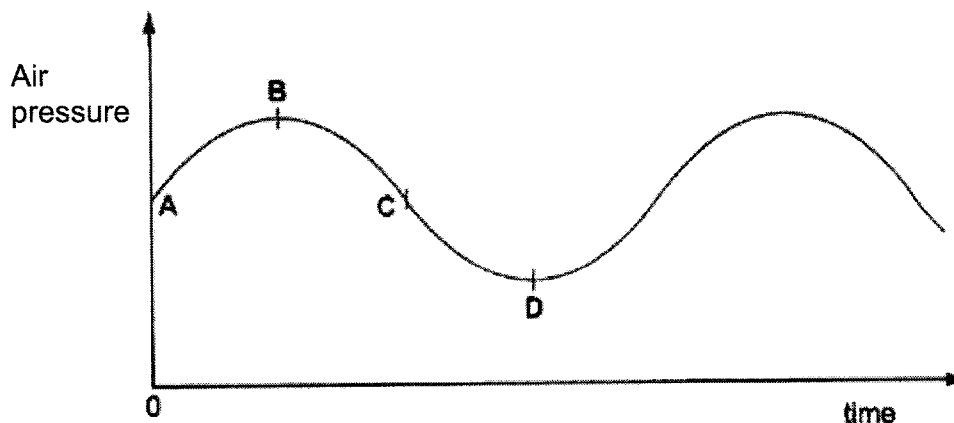

- 25 Two notes of the same loudness but different pitches are played on a musical instrument.

The two sound waves produced will have

- A the same amplitude and different speeds.
B the same amplitude and different frequencies.
C different amplitudes and same speed.
D different amplitudes and same frequency.
- 26 When a plastic rod is charged positively by friction,
- A it gains electrons B it loses electrons
C it gains protons D it loses protons
- 27 A stationary negative charge in an electric field experiences an electric force in the direction shown.



What is the direction of the electric field?

- A vertically downwards B vertically upwards
C horizontally to the left D horizontally to the right

- 28 The diagram shows a rectangular block with dimensions x , $3x$ and $5x$.

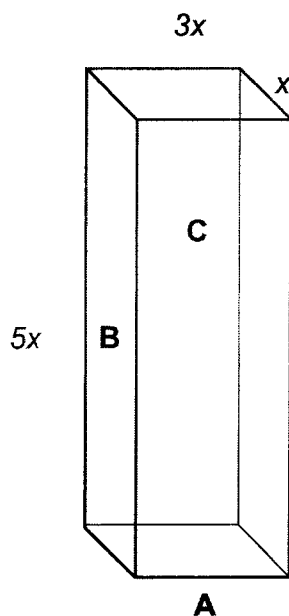

Electrical contact can be made to the block between opposite pairs of faces. For example, between the face labelled **A**, the top and bottom surfaces are connected.

Between which two faces would the minimum electrical resistance be obtained?

- A** the resistance is the same, whichever pair of faces is used
- B** the faces labelled **A**
- C** the faces labelled **B**
- D** the faces labelled **C**
- 29 Three resistors, each of resistance R , are arranged in the circuit below. What is effective resistance between point A and B?

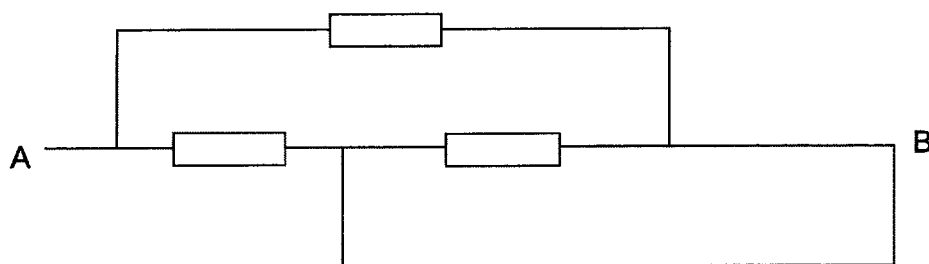

- A** $\frac{1}{3} R$ **B** $\frac{1}{2} R$ **C** $2 R$ **D** $3 R$

- 30 The diagram shows a potential divider formed using a light dependent resistor (LDR) and a $750\ \Omega$ resistor. The ends A and B of the potential divider are maintained at $0\ \text{V}$ and $+40\ \text{V}$ respectively. The resistance of the LDR is $2000\ \Omega$ in darkness and $200\ \Omega$ in bright light.

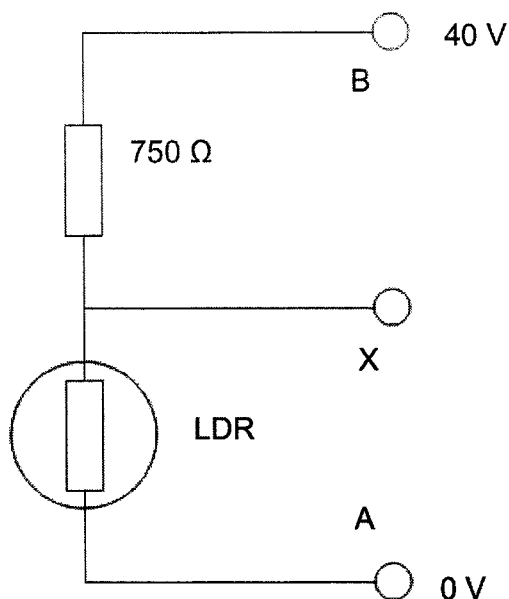

What range of potential difference can be obtained between B and X?

- A $0\ \text{V}$ to $8.4\ \text{V}$ B $0\ \text{V}$ to $29\ \text{V}$
 C $8.4\ \text{V}$ to $29\ \text{V}$ D $11\ \text{V}$ to $32\ \text{V}$
- 31 Which graph shows the I/V characteristic for a semiconductor diode?

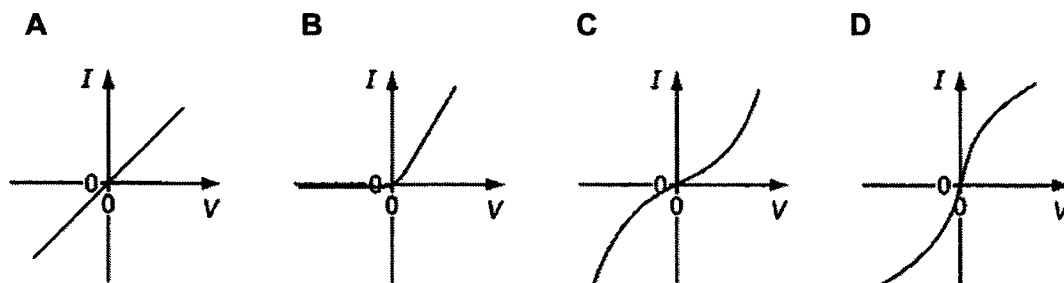

- 32 The diagram shows the wiring of a mains electric lamp. The lamp has a metal case and a switch. There are three wires X, Y and Z in the mains cable connected to the plug.

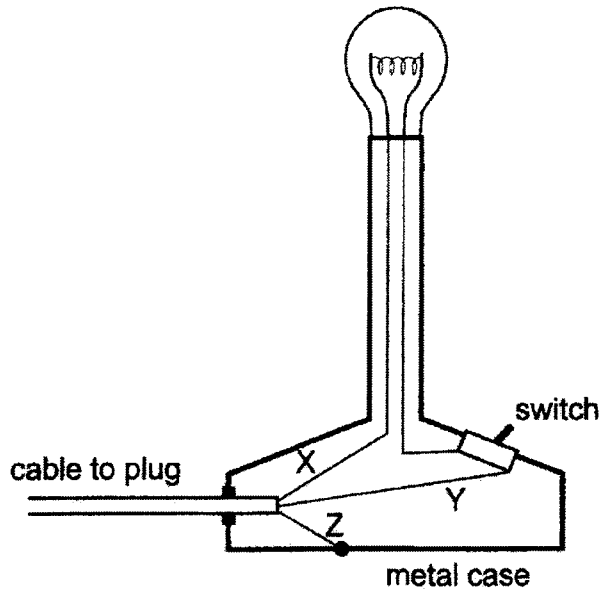

Which of the following is the correct wiring of the wires?

	wire X	wire Y	wire Z
A	live	earth	neutral
B	live	neutral	earth
C	neutral	earth	live
D	neutral	live	earth

- 33 The diagram below shows the information given on an electric iron.

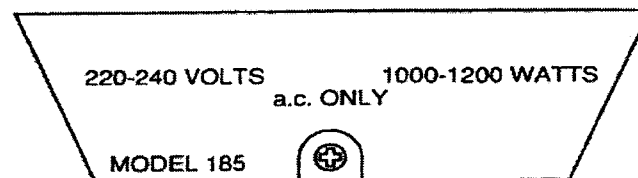

If electricity costs 25 cents per kWh, what is the cost of using this iron at maximum power for 10 hours?

- | | | | |
|----------|--------|----------|--------|
| A | \$2.50 | B | \$3.00 |
| C | \$250 | D | \$300 |

34 Which of the following gives the **wrong** choice of metal for their use?

	uses	choice of metal
A	A bar magnet	Steel
B	The core of an electromagnetic magnet	Iron
C	A magnetic shield	Steel
D	A compass needle	Steel

35 The diagram below shows a positive charge travelling horizontally into a region of uniform magnetic field.

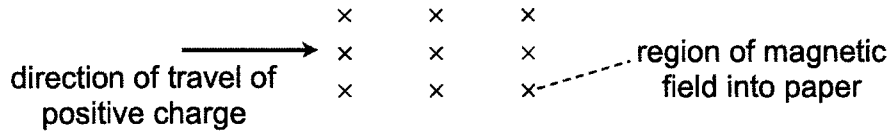

What is the direction of deflection of the positive charge when it is in the region of the magnetic field?

- A** upwards
 - B** downwards
 - C** into the plane
 - D** out of the plane
- 36 Each diagram is a cross-section through two parallel current-carrying conductors. In both conductors, the current direction is **into** the plane of the paper.

Which diagram shows the forces on the two conductors?

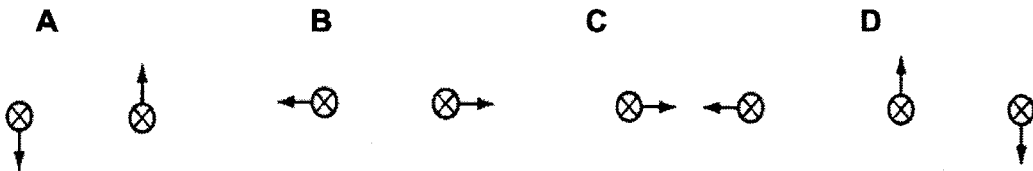

- 37 In the circuit shown, a control current is used to switch off a high current.

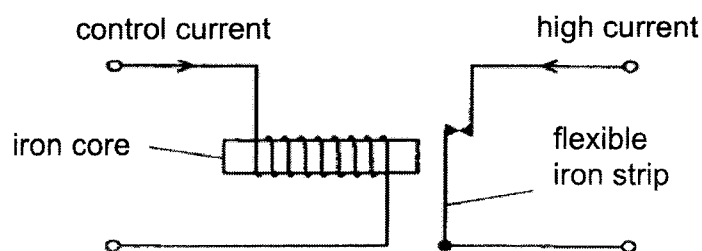

When the control current is switched on, the high current does not switch off.

Which of the following changes is **mostly likely** to switch off the high current?

- A moving the strip further away from the iron core
 - B reducing the number of turns around the iron core
 - C replacing the iron core by a steel core
 - D using a larger control current
- 38 When a coil is rotated in a magnetic field, the induced e.m.f. E varies with time.

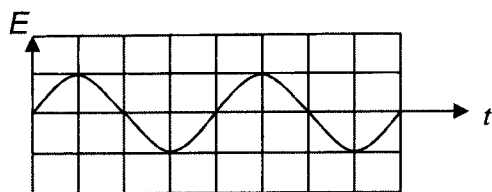

Which of the following graphs, drawn to the same scale, would be obtained if the speed of rotation of the coil is halved?

A

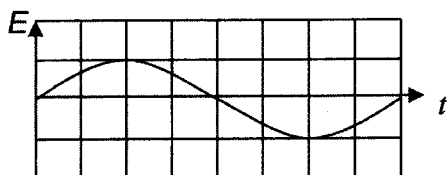

B

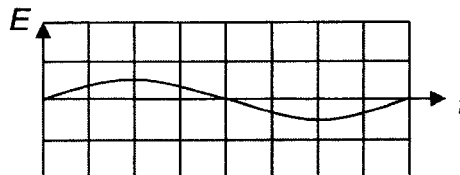

C

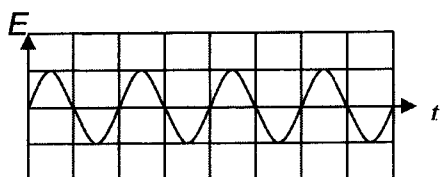

D

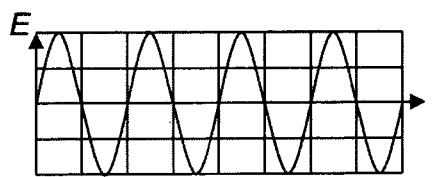

- 39 A student pushes the N-pole of a bar magnet into end Q of a long solenoid and observes a deflection to the right on the centre-zero ammeter.

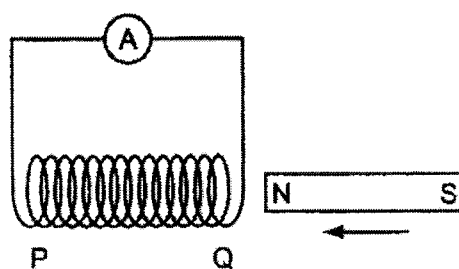

What produces a deflection in the same direction?

- A pulling the N-pole out of end Q
 B pulling the S-pole out of end P
 C pushing the N-pole into end P
 D pushing the S-pole into end P
- 40 The secondary coil of an ideal transformer is connected to a $30\ \Omega$ resistor as shown.

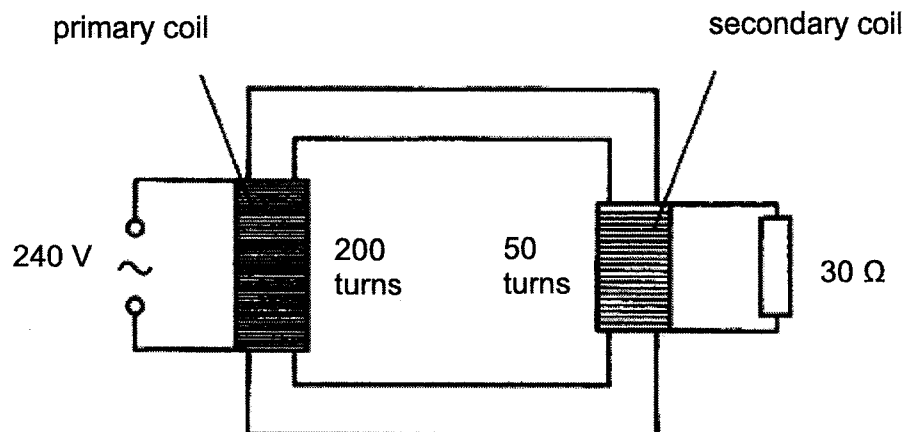

What is the current in the **primary** coil?

- A 0.5 A B 0.6 A C 2.0 A D 60 A

Candidate Name _____

Class _____ Register No. _____

--	--



**PEIRCE SECONDARY SCHOOL
PRELIMINARY EXAMINATION 2022
SECONDARY 4 EXPRESS**

PHYSICS
Paper 2 (Theory)

6091/02
29 Aug 2022
1 hour 45 minutes

Additional Material: Nil
Candidates answer on the Question Paper.

INSTRUCTIONS TO CANDIDATES

Write your name, class and register number in the spaces provided at the top of this page. Write in dark blue or black pen. You may use a soft pencil for any diagrams, graphs or rough working. Do not use staples, paper clips, glue or correction fluid.

Section A [50 marks]

Answer **all** questions.

Section B [30 marks]

Answer **all** questions. Question 11 has a choice of parts to answer.

Candidates are reminded that all quantitative answers should include appropriate units. The use of an approved scientific calculator is expected, where appropriate. Candidates are advised to show all their working in a clear and orderly manner, as more marks are awarded for sound use of Physics than for correct answers.

At the end of the examination, fasten all your work securely together.
The number of marks is given in brackets [] at the end of each question or part question.

PARENT'S SIGNATURE

--

For Examiner's Use

Section A	
Section B	
Total	80

This paper consists of **19** printed pages and **1** blank page.
Setter: Mr Kan Cheng Mun

Section A [50 marks]

Answer **all** questions in the spaces provided.

- 1 Fig 1.1 below shows how a hanging picture frame is supported by two strings that hang from a ceiling.

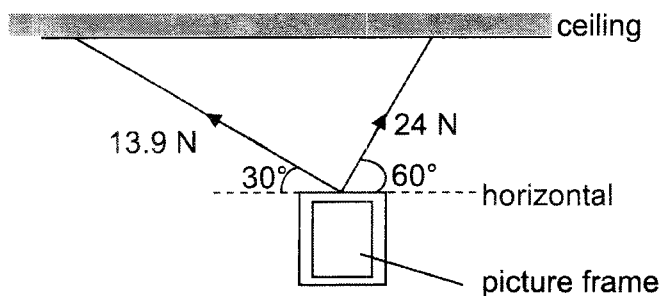

Fig 1.1

The tensions in the strings are 13.9 N and 24 N respectively.

- (a) With a suitable scale, draw a labelled vector diagram to show the resultant of the two tensions. Determine the magnitude and the direction of the resultant force.

Scale: :

magnitude of resultant force =

direction = [4]

- (b) Hence, determine the mass of the picture frame. The gravitational field strength is 10 N / kg .

mass = [2]

- 2 A designer plans to use some hollow aluminium balls as decorative pieces that float in a pond.

Fig 2.1 shows the cross section of one of these balls. The outer radius of the ball is 10.0 cm . The inner radius is r . The designer has to decide the thickness t of the aluminium so that the balls can float in water.

The density of water = 1.0 g / cm^3 , and volume of sphere = $\frac{4}{3} \pi r^3$

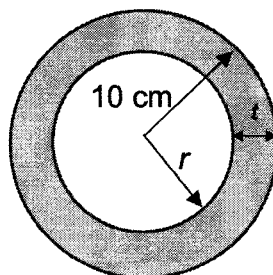

Fig 2.1

- (a) State the maximum density and hence calculate the maximum mass of the ball for it to remain afloat in water. It is assumed the air in the ball has negligible mass.

maximum density of aluminium ball =

mass of aluminium ball = [3]

- (b) The density of aluminium is 2.7 g / cm^3 . Calculate the maximum volume of aluminium in the ball for it to remain afloat in water.

maximum volume = [1]

- (c) By considering the volume of air in the ball and the inner radius r , calculate the maximum thickness t of the aluminium for the ball to remain afloat.

maximum t = [2]

3 (a) State the principle of moments.

.....
.....
..... [2]

(b) A 15000 N raft is supported by two ropes as shown in Fig. 3.1. Point A indicates the centre of gravity of the raft. The two ropes are 2.0 m apart.

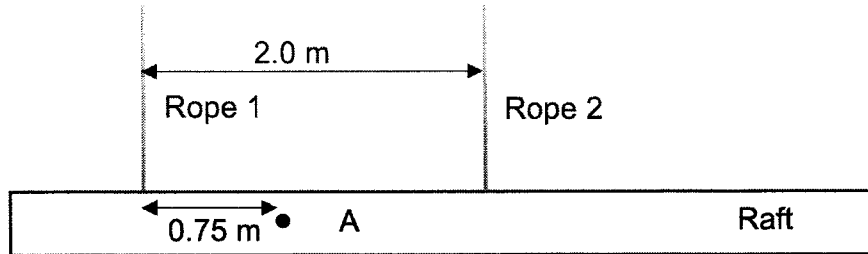

Fig 3.1

(i) The position of the center of gravity is not at its midpoint. Suggest what this implies about the distribution of the mass in the raft.

.....
..... [1]

(ii) By choosing the appropriate pivot or otherwise, calculate the tensions in both ropes.

tension in rope 1 =

tension in rope 2 = [3]

- 4 Fig 4.1 shows a fixed mass of air trapped in a cylinder with a piston that is fixed by a pin.

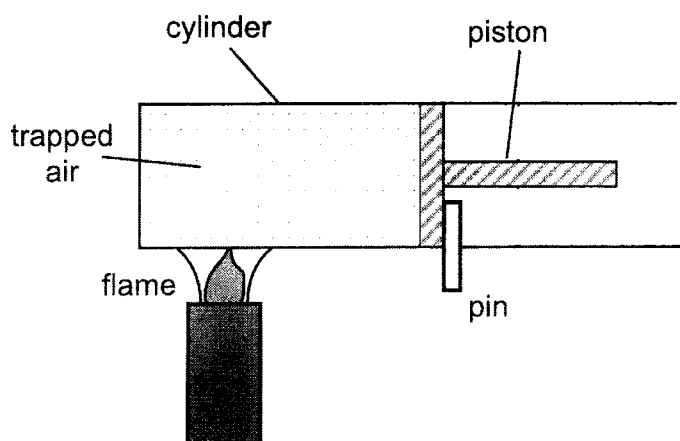

Fig 4.1

- (a) State and explain, using kinetic model, what happens to the pressure of the trapped air when the cylinder is heated.

.....

 [3]

- (b) The pin is removed, and the piston is allowed to move after the air is heated. State and explain, what would happen to the:

1. piston

.....
 [1]

2. final pressure of the trapped air in the cylinder.

.....

 [2]

- 5 (a) Use the kinetic theory of matter to explain why melting requires energy but there is no change in temperature.

.....

 [2]

- (b) A block of ice at 0 °C has a hollow in its top surface as shown in Fig 5.1.

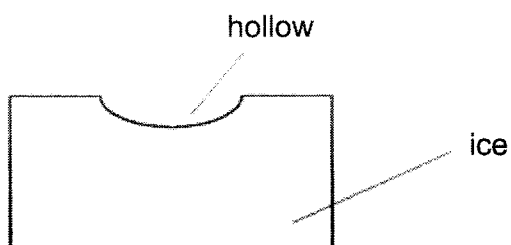

Fig 5.1

A mass of 0.16 kg of water at 100 °C is poured into the hollow. The water has specific heat capacity 4.20 kJ kg⁻¹ K⁻¹. Some of the ice melts and the final mass of water in the hollow is 0.365 kg.

- (i) Assuming there is no heat gain from the surrounding, state the temperature of the final mass of water in the hollow.

temperature = [1]

- (ii) Calculate the specific latent heat of fusion for the ice.

specific latent of fusion of ice = [2]

- (iii) In practice, thermal energy is gained from the surrounding. Suggest a way to reduce thermal energy gained from surrounding, state the method of heat transfer that was reduced. [2]

method of heat transfer	suggestion to reduce thermal energy gained

- 6 Bats emit ultrasound waves of high frequency and receive the reflected waves (echoes) to locate objects ahead. This process is called echolocation, which is illustrated in Fig. 6.1.

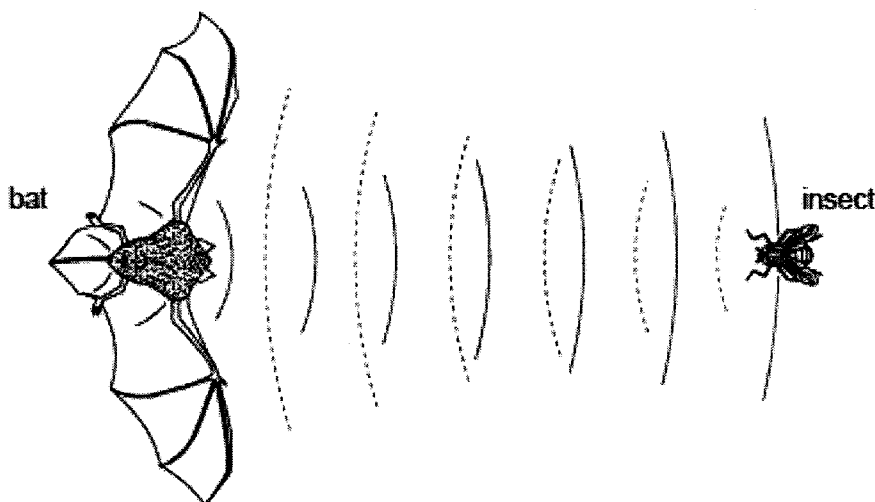

Fig 6.1

- (a) Sound waves are longitudinal in nature. Describe what is meant by a longitudinal wave.

.....

 [1]

- (b)** Bats uses ultrasound of frequency range of 20 kHz to 80 kHz. These sound waves travel at 340 m s^{-1} .

Calculate the range of wavelengths for this frequency range.

range of wavelengths = to [3]

- (c)** In a particular hunt by the bat, there is a time delay of 0.1 s between the emission of the sound wave and the arrival of the echo from the insect.

Calculate the distance between the bat and the insect.

distance between the bat and insect = [2]

7 Fig.7.1 shows a magnet, two compasses and two nails.

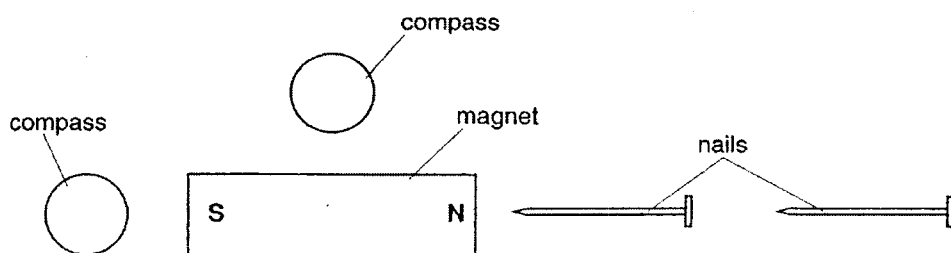

Fig.7.1

- (a) On Fig.7.1, draw an arrow in each compass to show the direction of the magnetic field of the magnet at the two positions. [2]
- (b) The magnet causes the nails to become magnetized by induction. Both ends of each nail become magnetic poles.

On Fig.7.1, mark a **N** or a **S** at both ends of each nail to show the magnetic poles. [2]

- (c) When the magnet is removed, the nails are still magnetized. Describe how to test whether the nails are still magnetized when they are away from the magnet.

.....

 [2]

- (d) Describe how the nails can be demagnetized.

.....

 [1]

- 8 Fig.8.1 shows two coils of copper wire wound on a soft-iron rod. Each coil can slide easily on the rod. Coil P is connected in series to a battery and a switch S. Coil Q is connected to a sensitive centre-zero meter. As S is closed, a deflection is seen on the meter.

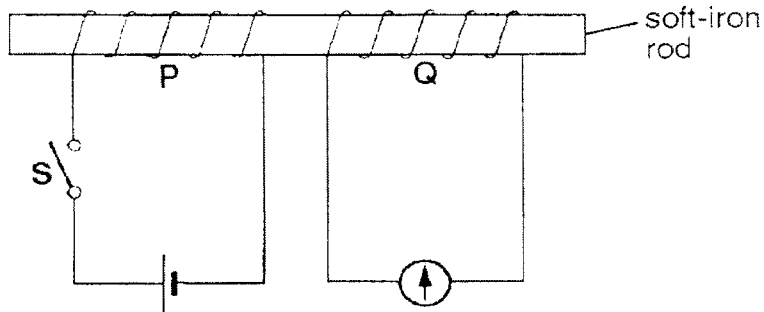

Fig.8.1

- (a) Explain briefly why there is a deflection on the meter.

.....

 [2]

- (b) State and explain what you would expect to observe as S is opened.

.....

 [2]

- (c) State and explain the effect on the deflection in (a) if the soft-iron rod was replaced with a wooden rod.

.....

 [2]

Section B (30 marks)

Answer **all** the questions from this section. Question 11 has a choice of parts to answer.

9 A thin copper wire has a radius of 0.09 mm and is 96 m long. The resistivity of copper is $1.7 \times 10^{-8} \Omega \text{ m}$.

(a) Show that the resistance of the copper wire is 64.1 Ω . [2]

(b) When the wire hangs vertically, suspended from one end, it stretches slightly under its weight.

(i) State and explain whether the cross-sectional area of the wire would increase or decrease when it stretches.

.....
.....
.....
..... [2]

(ii) Hence, or otherwise, state and explain what happens to the resistance of the wire.

.....
.....
..... [2]

- (c) A cable of length 96 m consists of 16 strands of this wires bundled together. Calculate the resistance of this cable.

resistance = [2]

- (d) The current in the cable in (c) is 2.5 A. Determine the power dissipated in the cable due to Joule heating.

power dissipated = [2]

- 10 (a) Fig 10.1 shows a rigid conducting wire loop connected to a 6.0 V battery through a 6.0 V, 3.0 W lamp. The circuit is standing on a top-pan balance. A uniform horizontal magnetic field strength 0.05 T acts at right angles to the straight top part of the conducting wire in the direction indicated in the diagram, i.e. into the paper. This magnetic field extends over the shaded area. The reading of the balance is 15.67 g

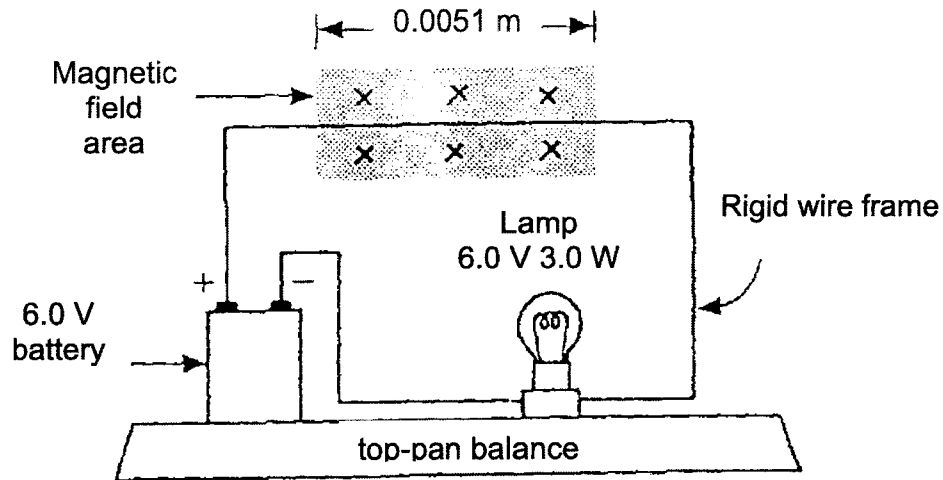

Fig. 10.1

Given that the force on the current-carrying wire, F , is by
 $F = B I L$ where B = magnetic field strength in Tesla (T)
 I = current in Ampere (A)
 L = length of wire in magnetic field in metre (m)

- (i) Compute the magnitude and direction of the force exerted on the conducting wire by the magnetic field.

direction of the force =

magnitude of the force = [4]

(ii) The direction of the magnetic field in Fig 10.1 was reversed to out of the paper. State and explain, without any calculation, how the reading on the balance would change.

.....
.....
.....
..... [2]

(b) James uses a pair of wireless earbuds to listen to music. These earbuds use ultra-high frequency radiowaves to receive the music from his mobile phone.

(i) The radiowaves that the earbuds use has a wavelength of 125 cm. Calculate the frequency of the radiowaves.

frequency =[2]

(ii) James accidentally brought his earbuds to swim. State and explain what happens to the **frequency** and **wavelength** of the radiowaves as they enter the water from air.

.....
.....
.....
.....
.....
..... [2]

11 Either

- (a) State what is meant by acceleration.

.....
[1]

- (b) Fig. 11.1 below shows the top view of a train consisting of an engine pulling a cargo carriage and 2 passenger carriages. The mass of the engine, cargo carriage and each of the passenger carriages are 3500 kg, 7500 kg and 4500 kg respectively. The frictional force of the track acting on the engine, cargo carriage and each of the passenger carriages are 2.0 kN, 4.0 kN and 3.0 kN respectively.

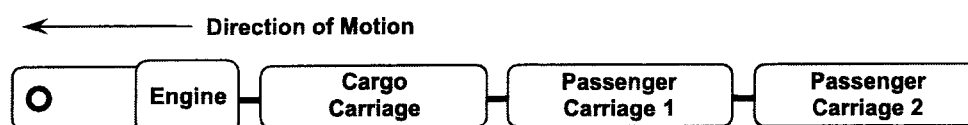

Fig 11.1

- (i) The train accelerates uniformly from rest to 30 m s^{-1} in 40 s. calculate the acceleration of the train.

acceleration = [1]

- (ii) Compute the resultant force of the train.

resultant force = [2]

- (iii) Determine the driving force required by the engine, assuming that the air resistance on the train is negligible.

driving force = [2]

(iv) Show, with clear workings, that the distance moved during this acceleration is 600 m. [2]

(v) Hence, or otherwise, compute the power of the engine during this period of acceleration.

power = [2]

11 OR

(a) State the two conditions required for light traveling in a medium to experience total internal reflection.

- 1.....

 2.....
 [2]

(b) Fig 11.2 (not drawn to scale) below is a semi-circular glass block, centre C, and with a refractive index of 1.5.

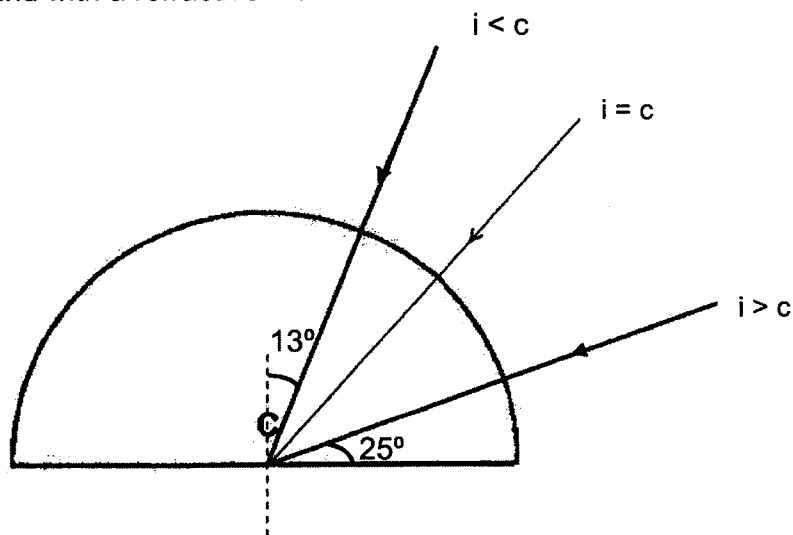

Fig 11.2

(i) Calculate the critical angle c of the glass block.

critical angle, $c = \dots\dots\dots$ [2]

(ii) Three rays are incident perpendicularly on the glass block as shown in Fig 11.2.

By making appropriate calculations, show the workings and label how the rays interacted after point C at the plane surface for: [5]

1. $i < c$. Label the angle from normal at C as M.
2. $i = c$. Label the angle from normal at C as N.
3. $i > c$. Label the angle from normal at C as L.

State the values of the angles of M, N and L.

(c) State a real-life application where total internal reflection was used.

..... [1]

END OF PAPER

2022 Prelim Sec 4 Physics (5059/01)**Answer Key**

1	2	3	4	5	6	7	8	9	10
A	B	C	C	D	C	A	B	A	A
11	12	13	14	15	16	17	18	19	20
D	A	B	A	A	D	A	D	C	A
21	22	23	24	25	26	27	28	29	30
C	C	C	B	B	B	C	D	B	D
31	32	33	34	35	36	37	38	39	40
B	D	B	C	A	C	D	B	D	A

A -10

B - 10

C - 11

D - 9

	Cannot accept: Placing near another metal and the nail is attracted to it (the test metal could be magnetized). Accept: place near a compass, and see deflection (d) heating, hammering or using a coil with a Alternating current	B1
8	(a) when the switch is turned on, coil P creates a magnetic field that could be experienced by coil Q. By Faraday's Law, Q experienced a change in magnetic flux, it would induce a current in Q	B1 B1
	(b) As S is opened, the magnetic field in coil P is destroyed. As coil Q experience a change in magnetic flux (from magnetic field to none), it would induce a current in Q. (opposite in direction to (a))	B1 B1
	(c) As wood is not a soft magnetic material, the magnetic flux/field experienced by coil Q will be lower. The current induced would also be lower.	B1 B1
Qn		Marks
9	(a) $A = \pi r^2 = 3.142 \times (9 \times 10^{-5})^2 = 2.545 \times 10^{-8} \text{ m}^2$ $R = \rho \frac{L}{A} = 1.7 \times 10^{-8} \times \frac{96}{2.545 \times 10^{-8}}$ $= 64.1 \Omega$ (shown)	M1 M1
	(b)(i) $V = A \times l$ For the same volume, as length increases, The cross-sectional area of the wire decreases.	B1 B1
	ii, with the length increasing and cross-sectional area decreasing, by $R = \rho \frac{L}{A}$, the resistance of the wire will increase	B1 B1
	(c) with 16 wires bundled together, it is as if it is 16 resistors parallel to each other. Hence, the effective resistance, $\frac{1}{R_{\text{eff}}} = \frac{1}{R} \times 16$ $R_{\text{eff}} = \frac{R}{16} = 4.01 \Omega$ Accept: the effective area increases by 16 times, and so the resistance $\frac{R}{16}$.	M1 A1
	(d) $P = I^2 R = 2.5^2 \times 4.01$ $= 25.1 \text{ W}$	M1 A1
10	ai) upward force (by Fleming left hand rule $P = VI \rightarrow 3 = 6 \times I \rightarrow I = 0.5 \text{ A}$ $F = BIL$ $= 0.05 \times 0.5 \times 0.0051$ $F_{\text{mag}} = 0.0001275 \text{ N} = 0.000128 \text{ N}$ ii) When the magnetic field is reversed, it would exert a downward force, and so it would cause the reading on the balance to be higher. Allow ecf	B1 M1 B1 A1 B1 B1
	bi) $v = f \lambda$ $3 \times 10^8 = f \times \frac{125}{100}$ $f = 2.4 \times 10^8 \text{ Hz}$	M1 A1

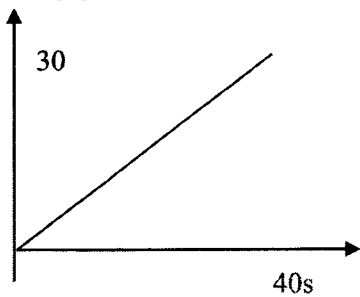
	<p>ii) When radiowaves enter water from air, the frequency remains the same. The speed of the wave reduces in speed while in water. With $v = f \lambda$, hence, the wavelength decreases.</p>	B1 B1
11Ei	a) Acceleration is the rate of change in velocity per unit time	B1
	<p>b) $a = \frac{30-0}{40} = 0.75 \text{ m s}^{-2}$</p> <p>ii) Total mass = $3500 + 7500 + (4500 \times 2) = 20\,000 \text{ kg}$ $F = ma = 20\,000 \times 0.75 = 15 \text{ kN}$</p> <p>iii) $F_{\text{net}} = \text{Driving force} - \text{Frictional forces}$ $15 \text{ kN} = \text{Driving force} - (2 + 4 + 3 + 3) \text{ kN}$ Driving force = 27 kN</p>	A1 M1 A1 M1 A1
	<p>iv) using graph of speed time graph</p>  <p>Area = $\frac{1}{2} \times 30 \times 40 = 600 \text{ m}$ Accept: since acceleration is constant, average speed is $30/2 = 15 \text{ m/s}$ Therefore, distance = average speed $\times 40\text{s} = 600 \text{ m}$</p>	M1 M1
	<p>v) Power = $\frac{\text{Work Done}}{\text{Time}} = \frac{\text{Force} \times \text{Distance}}{\text{Time}}$</p> <p>= $\frac{27\,000 \times 600}{40}$ = 405 kW</p>	M1 A1
11Or	<p>a) 1. The angle of incidence must be greater than the critical angle 2. Light travels from an optically denser medium to an optically less dense medium</p>	B1 B1
	<p>b) $n = \frac{1}{\sin c}$</p> <p>$1.5 = \frac{1}{\sin c}$</p> <p>$c = \sin^{-1}\left(\frac{1}{1.5}\right) = 41.81^\circ$</p>	M1 A1
	<p>ii) 1. With $i < c$, the ray undergoes refraction. $n_i \sin i = n_r \sin r$ $1.5 \sin 13 = 1 \sin r$ $r = 19.7^\circ$</p>	M1

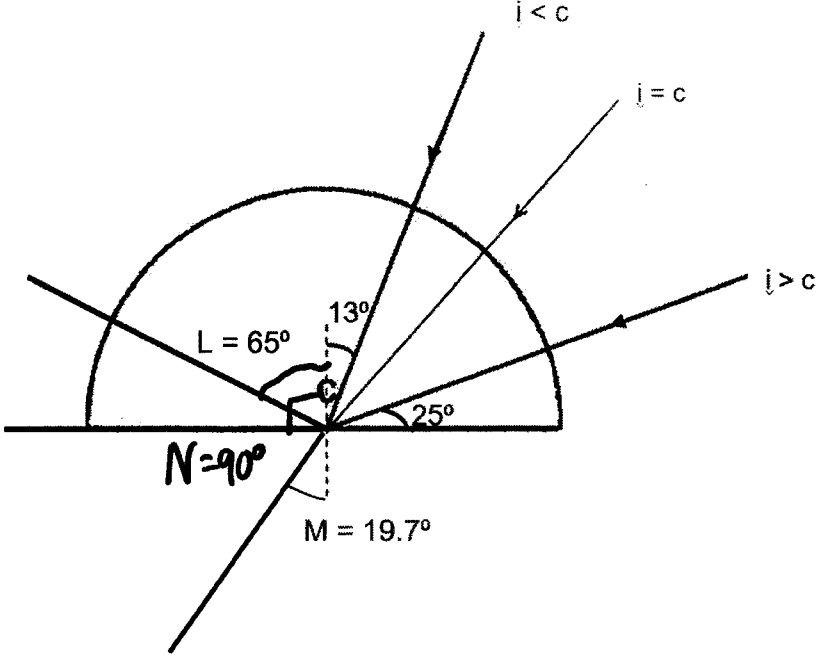
	<p>2. with $i = c$, the ray should refract exactly at 90°, (show on diagram)</p> <p>3. with $i > c$, the ray should undergo total internal reflection, when angle of incidence = $(90 - 25) = 65^\circ$, and so the angle of reflection is 65°</p>	M1
		A3
	<p>[1] for each correctly labelled angle on Fig</p>	
	<p>(c) Transmission of data using optical fibres.</p>	B1

Note:

- 3SF for final answer – For each mistake, deduct 1 mark up to a maximum of 3 marks per paper.
(For exact value, need not write answer to 3 SF.)
- No unit written for final answer - For each mistake, deduct 1 mark up to a maximum of 3 marks per paper.
- Don't give $\frac{1}{2}$ mark.

Setter: Mr Kan Cheng Mun

THE END