



2020 PRIMARY 4 SEMESTRAL ASSESSMENT 2

Name : _____ () Date: 29 October 2020

Class : Primary 4 ()

Time: 8.00 a.m. - 9.00 a.m.

Parent's Signature : _____ Marks: _____ / 100

MATHEMATICS

PAPER 1

(Booklet A and Booklet B)

Time for Paper 1 is **1 hour**.

Do not open this booklet until you are told to do so.

Read and follow all instructions carefully.

Answer all questions.

Booklet A	20
Booklet B	40
Total for Paper 1	60

Paper 1 Booklet A

Multiple Choice Questions

Questions 1 to 10 carry 2 marks.

For each question, four options are given. One of them is the correct answer.

Make your choice (1, 2, 3 or 4).

Shade the correct oval (1, 2, 3 or 4) on the Optical Answer Sheet. (20 marks)

1. Twenty-eight thousand and fifty-four in figures is _____.

(1) 28 540

(2) 28 504

(3) 28 054

(4) 2854

2. The figure shown is made up of identical triangles.

What fraction of the figure is shaded?

(1) $\frac{7}{17}$

(2) $\frac{7}{23}$

(3) $\frac{7}{24}$

(4) $\frac{17}{24}$

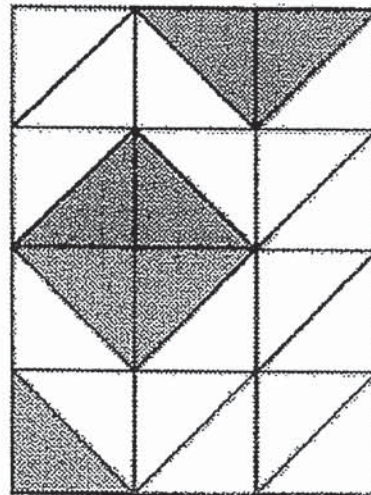

3. One of the lines in the figure is parallel to CD.
Which line is parallel to CD?

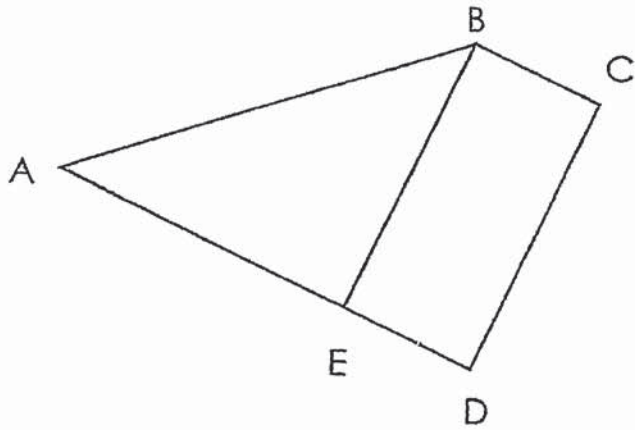

- (1) BE
 - (2) DE
 - (3) BC
 - (4) AC
4. Which of the following is a factor of both 36 and 45 ?

- (1) 8
- (2) 9
- (3) 12
- (4) 15

5. The figure shown is made up of a square S of side 3 cm and a rectangle R with breadth 4 cm. What is the length of the rectangle?

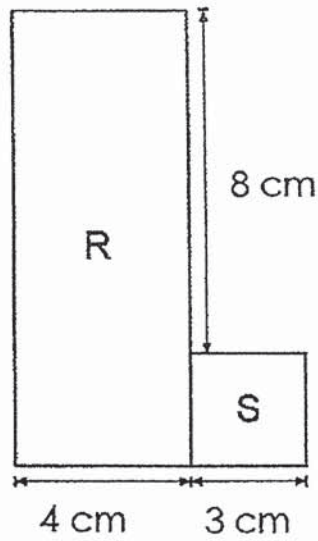

- (1) 7 cm
(2) 8 cm
(3) 11 cm
(4) 12 cm
6. Arrange the following decimals from the smallest to the greatest.

3.8 , 0.38 , 3.08 , 0.83

- (1) 0.38, 0.83, 3.08, 3.8
(2) 0.83, 0.38, 3.08, 3.8
(3) 0.38, 3.8, 3.08, 0.83
(4) 0.83, 0.38, 3.8, 3.08

7. Find the mass of the bananas.

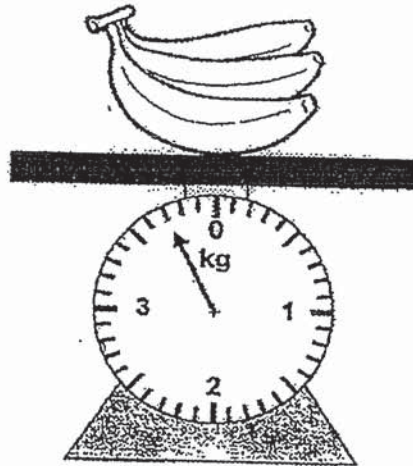

- (1) 370g
- (2) 307g
- (3) 3 kg 70g
- (4) 3 kg 700g

8. The square below has an area of 64 cm^2 .
What is the perimeter of the shaded part?

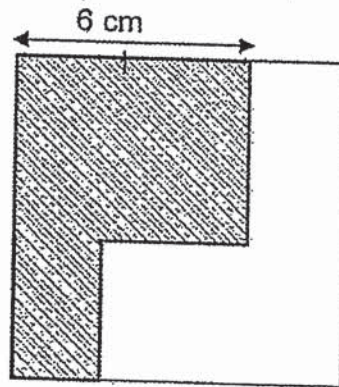

- (1) 24 cm
- (2) 28 cm
- (3) 30 cm
- (4) 32 cm

9. Maying and Siti bought masks and donated them.
They spent a total of \$2600.

Maying spent $\frac{3}{5}$ of the amount.

How much did Maying spend?

- (1) \$520
- (2) \$1040
- (3) \$1560
- (4) \$2080

10. Mr Tan had 8000 *mℓ* of oil. He used 4500 *mℓ* of the oil and poured the remaining oil equally into 5 cans. How much oil was there in each can?

- (1) 3500 *mℓ*
- (2) 1600 *mℓ*
- (3) 900 *mℓ*
- (4) 700 *mℓ*

Paper 1 (Booklet B)

Short Answer Questions

Questions 11 to 30 carry 2 marks each. Write your answers in the boxes provided. For questions which require units, give your answers in the units stated.

(40 marks)

11. What is the value of the digit 8 in 89 465 ?

12. Write the missing number in the number pattern below.

13 000 , 12 200 , 11 400 , 10 600 , _____ , 9 000

13. Find the value of $1 - \frac{1}{9} - \frac{1}{3}$.

14. Express $\frac{71}{100}$ as a decimal.

15. Write the decimal represented by A.

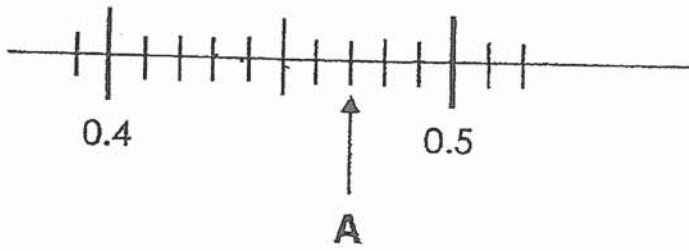

16. Round 67 710 to the nearest hundred.

17. In the figure, name the two angles that are greater than 90° .

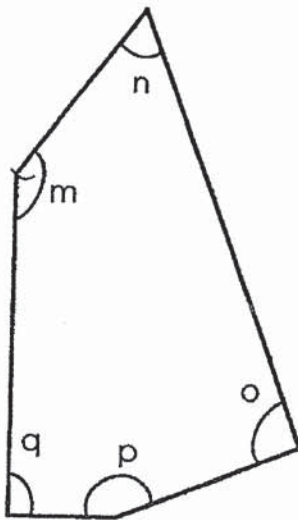

18. In the figure shown, ABCD is a rectangle. Find $\angle CAE$.

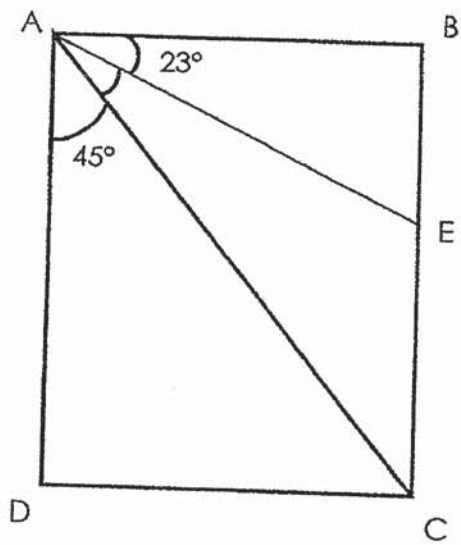

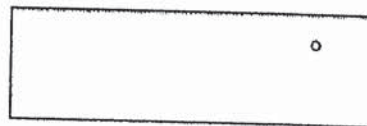

19. Measure and write down the size of $\angle x$.

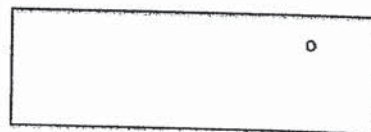
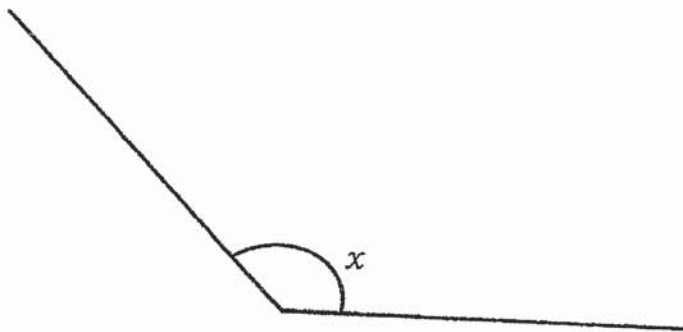

20. AB is a line of symmetry. Complete the symmetric figure.

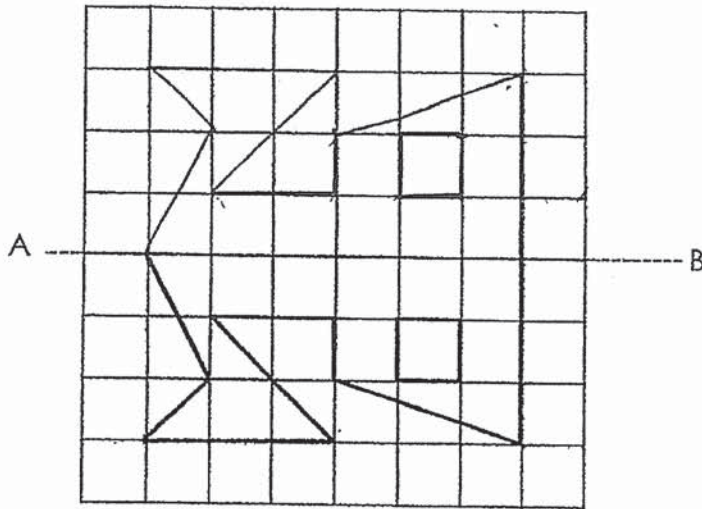

21. A rectangular sheet of paper measures 25 cm by 15 cm. A square of side 5 cm and a rectangle measuring 6 cm by 4 cm were cut from it. What is the perimeter of the remaining paper?

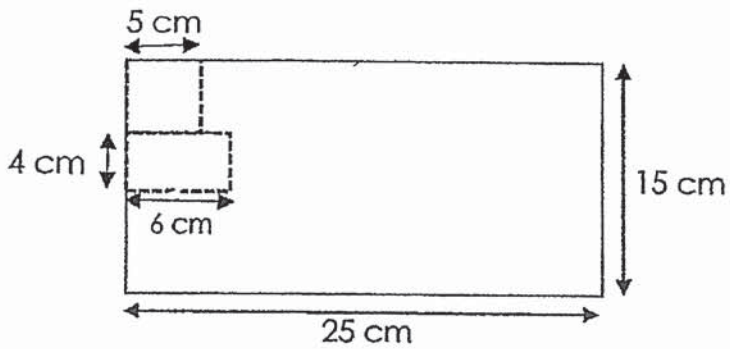

cm

22. Find the mass of x. Give your answer in grams.

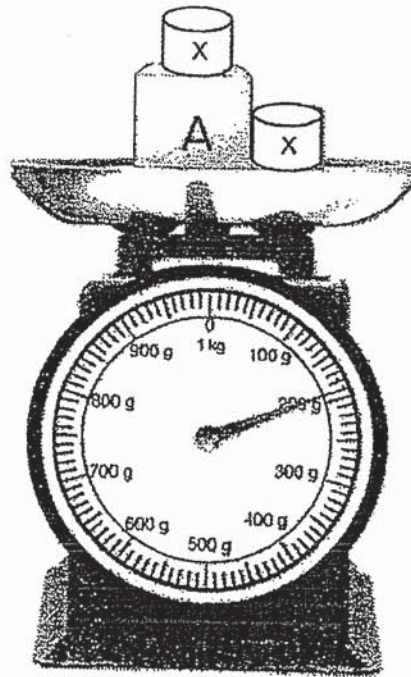
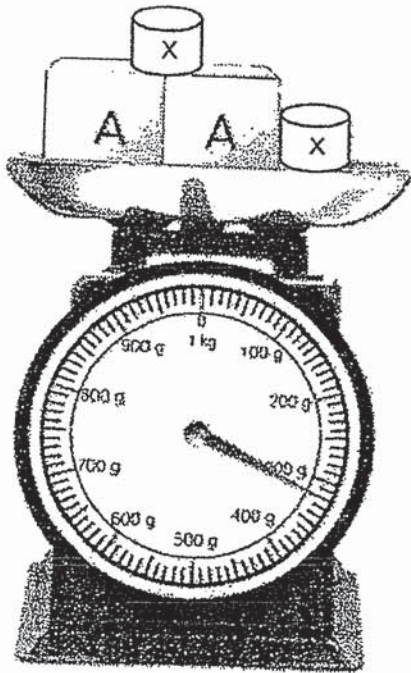

g

23. Ken had some money as shown below.
He spent \$8.60 on some stationery.
How much money had he left?



\$

Use the bar graph below to answer **questions 24 and 25**.

The bar graph shows the number of tickets sold for a magic show from Monday to Friday.

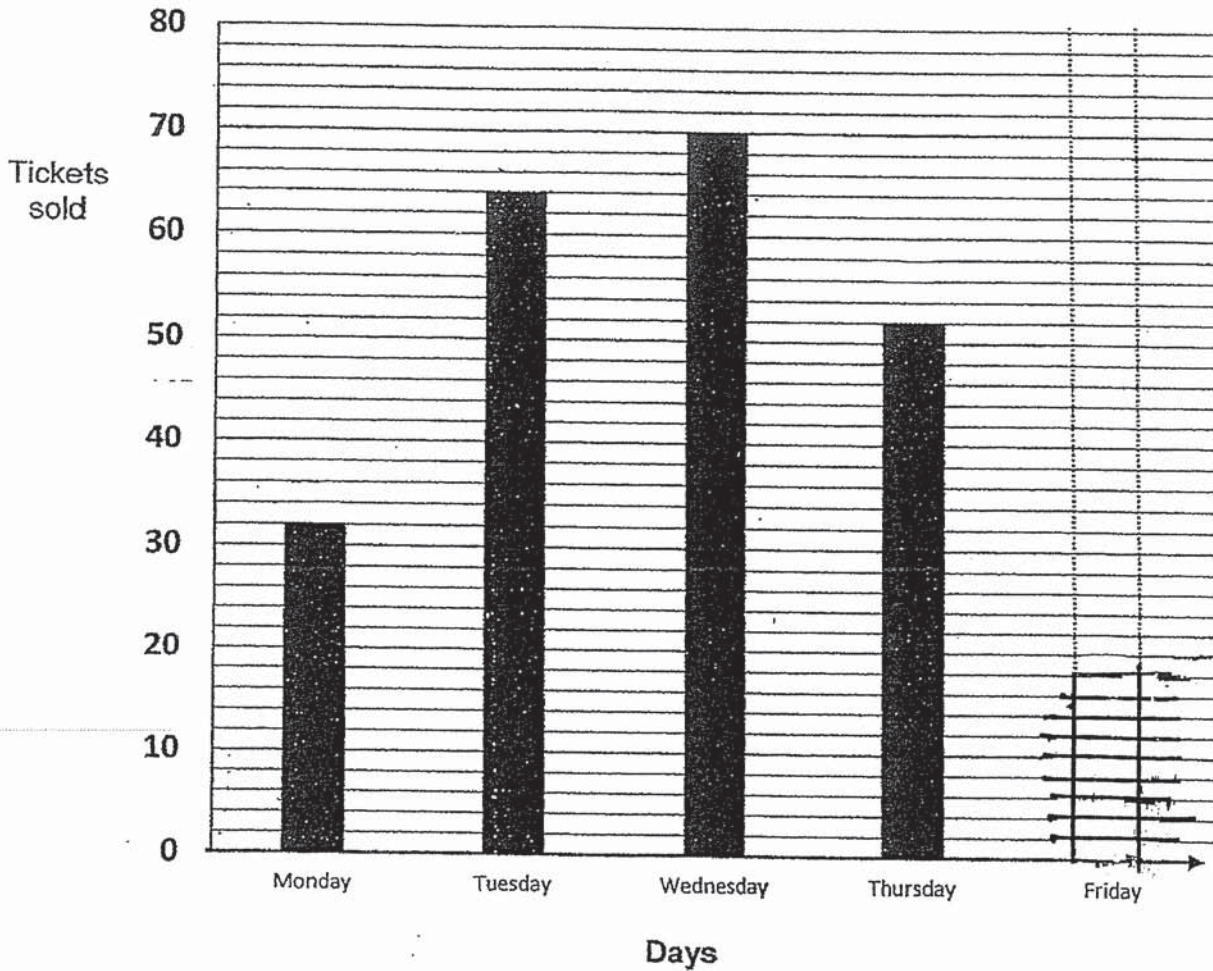

24. The number of tickets sold on Monday was twice the number of tickets sold on Friday. **Draw** the bar for Friday.

25. What was the difference in the sale of tickets between Wednesday and Thursday?

26. The bar graph shows the amount of rainfall over 5 months.

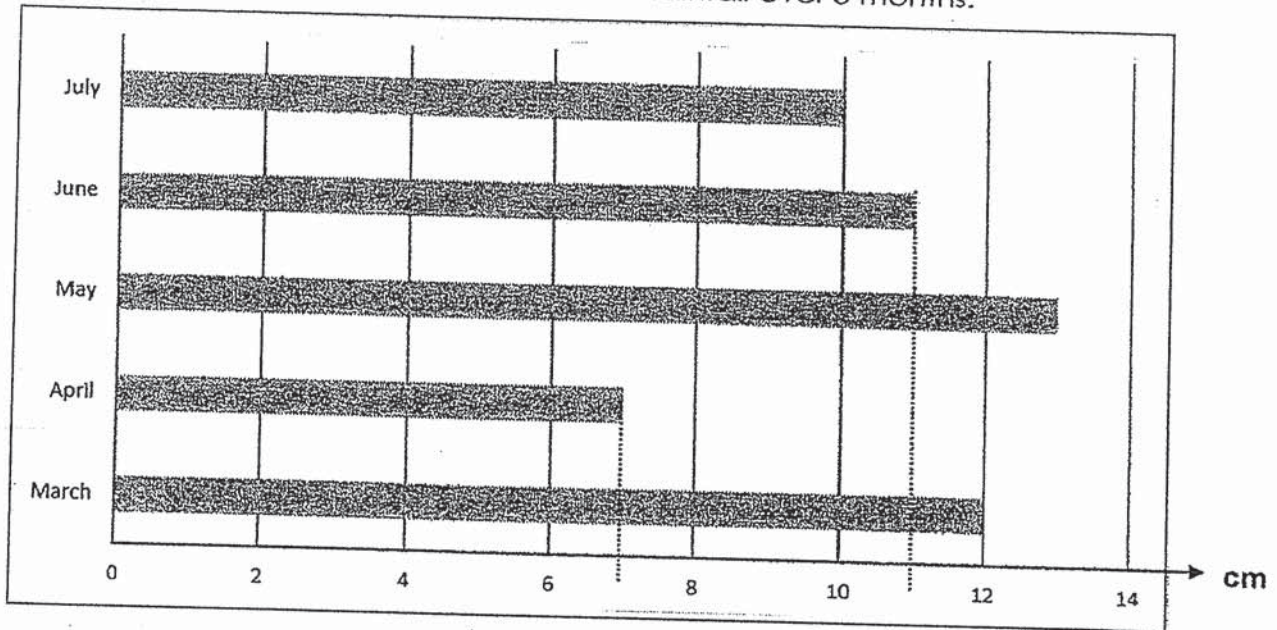

In which month was the rainfall less than 9 cm?

27. In the figure, EFGH is a rectangle. The area of the rectangle is 4 times the area of the shaded part. What is the area of the **unshaded** part?

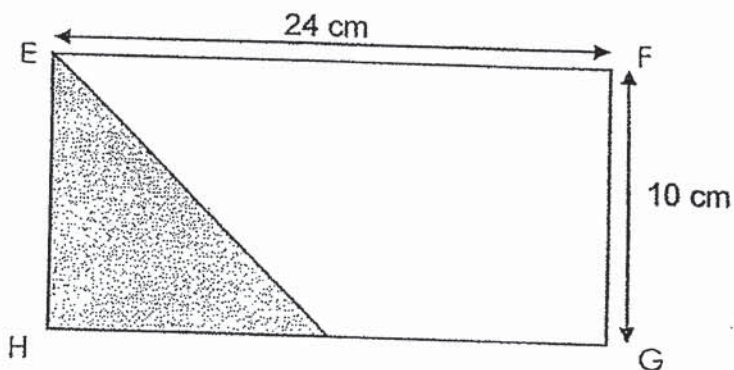
 cm^2

28. Baker Mae wants to pack 50 muffins into boxes.
Each box can hold 6 muffins.

What is the **least** number of boxes needed to pack all the muffins?

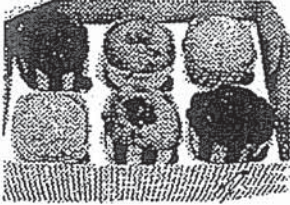

29. Joyce goes swimming every 4 days and Sophie every 6 days.
They swim on the same day on 31 October.

Which are the common dates they will go swimming in November?

NOVEMBER 2020

Monday	Tuesday	Wednesday	Thursday	Friday	Saturday
1	2	3	4	5	6
8	9	10	11	12	13
15	16	17	18	19	20
22	23	24	25	26	27
29	30				

30. a) Benny is standing at **Point B** and facing the Food Court.
 How many turns in the anticlockwise direction must he make in order to face the Community Centre. ?

b) Benny is now facing the Community Centre.

He makes a $\frac{3}{4}$ - turn clockwise. Where will he be facing?

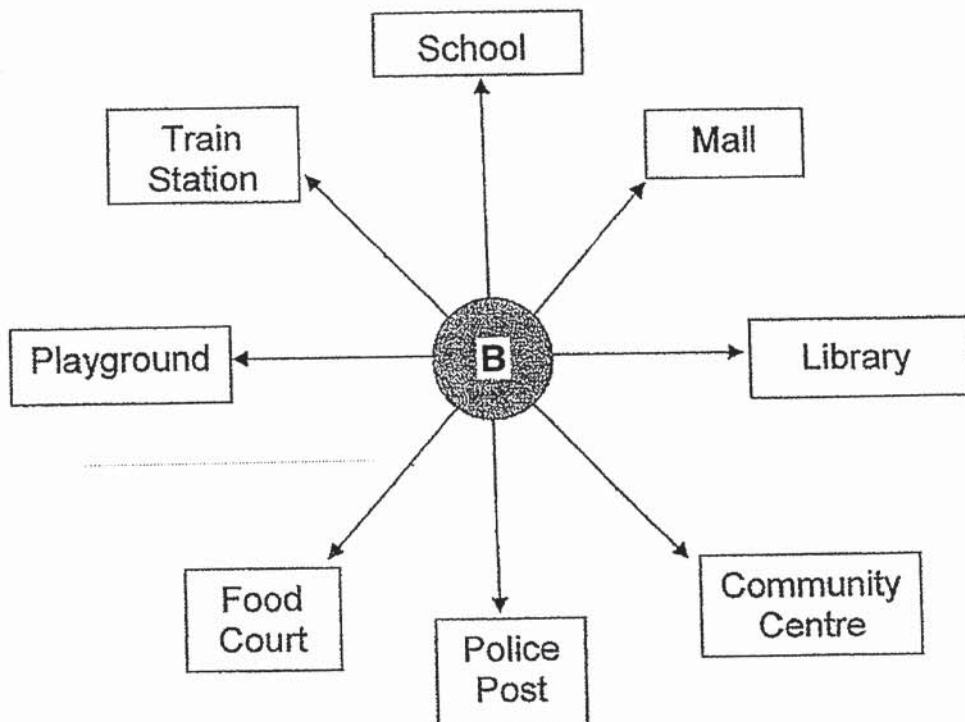

a)

b)

End of Paper 1



2020 PRIMARY 4 SEMESTRAL ASSESSMENT 2

Name: _____ () Date: 29 October 2020

Class: Primary 4 ()

Time: 11.30 a.m - 12.30 p.m

Parent's Signature: _____

MATHEMATICS

PAPER 2

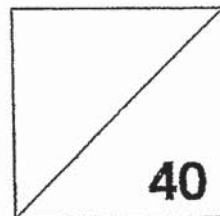

INSTRUCTIONS TO CANDIDATES

1. Write your name, class and register number.
2. Do not turn over this page until you are told to do so.
3. Follow all instructions carefully.
4. Answer all questions.
5. Show your working clearly as marks are awarded for correct working.
6. The duration for Paper 2 is **1 hour**.

Questions 1 to 10 carry 4 marks each. Show your working clearly in the space provided for each question and write your answers in the spaces provided. For questions which require units, give your answers in the units stated. (40 marks)

1. (a) **Draw** a square, ABCD. The line AB is drawn for you. (1)

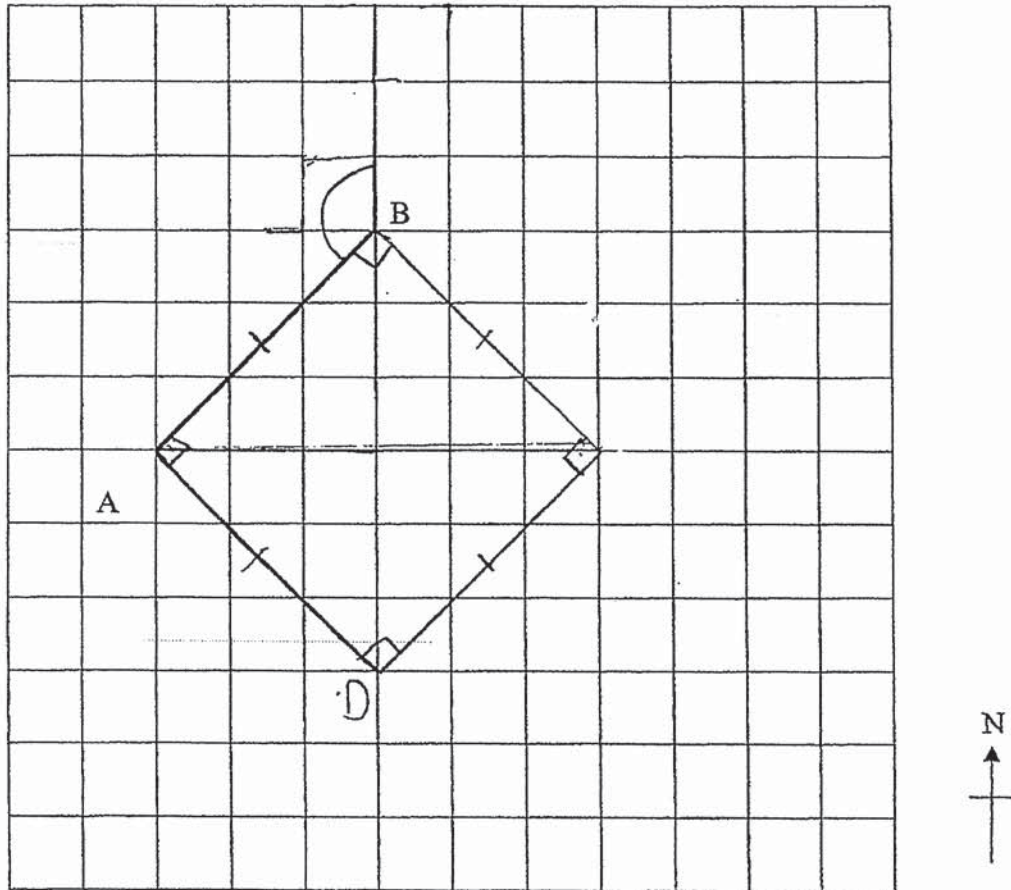

(b) **Join** the diagonal AC. **Measure** the length of AC.
Give your answer to the **nearest cm**.

Ans: AC = _____ cm. (1)

(c) **Draw** a line BE such that angle $\angle ABE = 135^\circ$. **Mark** the angle. (1)

(d) **Measure** $\angle EBC$.

Ans: $\angle EBC =$ _____ $^\circ$ (1)

2. Ron, Karl and Munira collected a total of 1200 picture cards.
Ron collected 327 picture cards. He collected 93 fewer picture cards than Karl.
How many picture cards did Munira collect ?

Munira collected _____ picture cards.

Ans: _____ (1)

3. ABCD is a square of side 20 m.
 AD is twice the length of DE.
 Find the area of the shaded part.

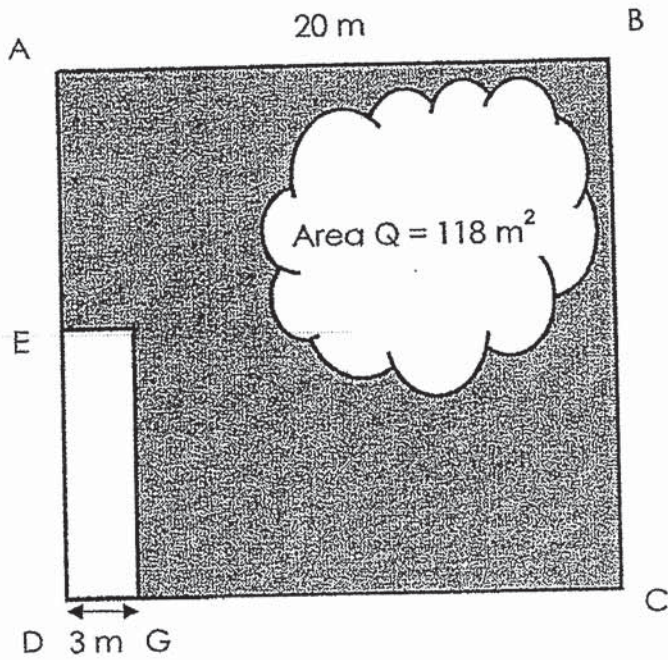

The area of the shaded part is _____

Ans: _____ (4)

4. At ABC School, 336 pupils took part on Sports Day.
 $\frac{1}{3}$ of them were from Primary 1, $\frac{1}{2}$ of them were from Primary 2
and the rest of the pupils were from Primary 3.
How many Primary 3 pupils took part ?

_____ Primary 3 pupils took part.

Ans: _____ (4)

5. Ribbon A is 52.2 cm long. It is 4 times as long as Ribbon B.
Ribbon C is 10.9 cm longer than Ribbon B.
How many centimetres longer is Ribbon A than Ribbon C?

Ribbon A is _____ longer than Ribbon C.

Ans: _____ (4)

6. Mr Gopal had less than 50 face masks.
He could pack them equally in packets of 3 masks or in packets of 4 masks.

(a) What was the **greatest possible** number of masks he had ?

(b) While packing, one of the masks was dirtied and had to be thrown away.
Mr Gopal decided to repack the remaining masks into packets of 5 masks each. How many packets of masks did he get ?

(a) He had _____ face masks.

(b) He had _____ packets of face masks.

Ans: a). _____ (2)

b). _____ (2)

7. 2 similar book shelves and 3 similar tables cost \$5040.
1 book shelf costs thrice as much as 1 table.
What is the cost of the 2 book shelves ?

The cost of the 2 book shelves is _____

Ans: _____ (4)

8. Aishah and Bella had 219 stickers.

After Aishah used $\frac{1}{3}$ of her stickers and Bella used 39 stickers,

they had the same number of stickers left.

How many stickers did Bella have at first?

Bella had _____ stickers at first.

Ans: _____ (4)

9. A movie was shown from 10.15 a.m. to 12.45 p.m.
The same movie was then shown at 1.30 p.m.
What time did the second movie end?
(You may use the timelines below to show your working.)

The movie ended at _____

Ans: _____

10. Study the pattern below.



Figure 1

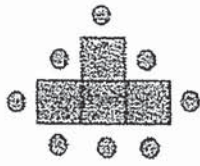

Figure 2

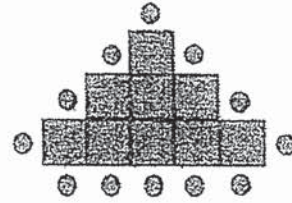
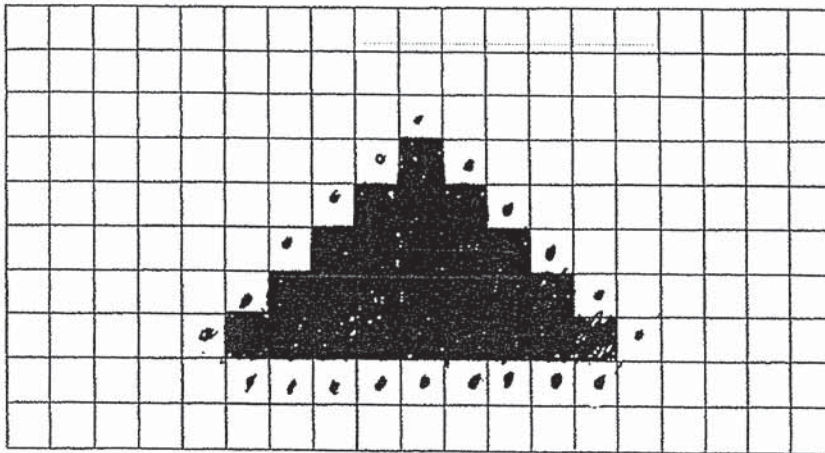

Figure 3

(a) Complete the table. (1)

Figure	1	2	3	4
Number of squares	1	4	9	
Number of dots	4	8	12	

(b) Draw and colour Figure 5 in the square grid below. (1)



(c) How many dots are there in Figure 202 ?

Ans: Figure 202 : _____ dots (2)

End of Paper 2

ANSWER KEY

YEAR : 2020

LEVEL : PRIMARY 4

SCHOOL ; TAO NAN SCHOOL

SUBJECT: MATHEMATICS

TERM: SA2

BOOKLET A

Q1	3	Q2	3	Q3	1	Q4	2	Q5	3
Q6	1	Q7	4	Q8	2	Q9	3	Q10	4

BOOKLET B

Q11. 80000

Q12. 9800

Q13. $\frac{5}{9}$

Q14. 0.71

Q15. 0.47

Q16. 67700

Q17. ANGLE M AND P

Q18. 22°

Q19. 134°

Q20.

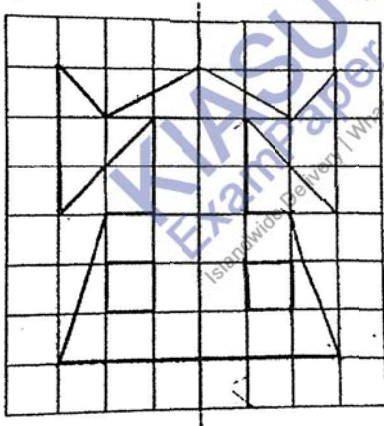

Q21. $25+15+20+5+1+4+6+6=82$

Q22. 30 g

Q23. \$11.45

Q24.

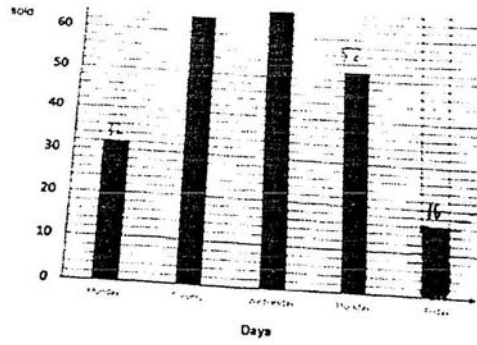

Q25. 18 tickets

Q26. April

Q27.

$$24 \times 10 = 240$$

$$240 \div 4 = 60$$

$$240 - 60 = 180$$

Q28.

$$50 \div 6 = 8 \text{ R}2$$

$$8 + 1 = 9$$

Q29. 12 November and 24 November

Q30.

a) $\frac{1}{4}$ turn

b) Mall

PAPER 2

Q1.

a)

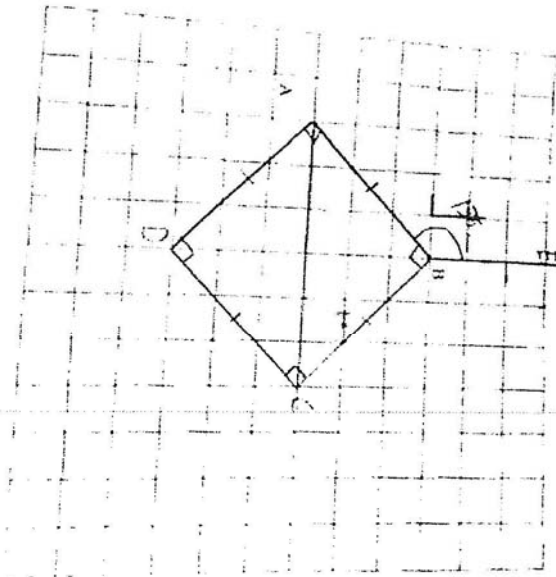

b) 6cm

d) 135°

Q2.

$$327 \times 2 = 654$$

$$654 + 93 = 747$$

$$1200 - 747 = 453$$

$$453 + 327 + 327 + 93 = 1200$$

ans: 453

Q3.

$$20 \div 2 = 10$$

$$10 \times 3 = 30$$

$$20 \times 20 = 400$$

$$400 - 30 = 370$$

$$370 - 118 = 252$$

Q4.

$$336 \div 6 = 56$$

Q5.

$$52.2 \div 4 = 13.05$$

$$13.05 + 10.9 = 23.95$$

$$52.2 - 23.95 = 28.25$$

Q6.

a) $3 \times 4 = 12$

$112 \times 4 = 448$

b) $48 - 1 = 47$

$47 \div 5 = 9 \text{ R}2$

Answer :9

Q7.

$5040 \div 9 = 560$

$560 \times 6 = 3360$

Q8.

$219 - 39 = 180$

$180 \div 5 = 36$

$36 \times 2 = 72$

$72 + 39 = 111$

Q9. 4pm

Q10.

Figure	1	2	3	4
Number of squares	1	4	9	16
Number of dots	4	8	12	16

b)

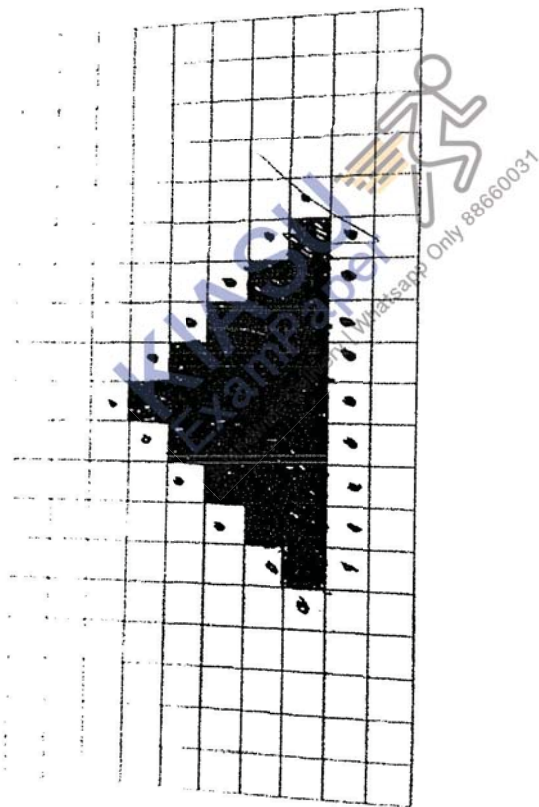

c) $202 \times 4 = 808$

LF
END