

PEI CHUN PUBLIC SCHOOL
End-of-Year Examination, 2020

MATHEMATICS
PRIMARY 4

BOOKLET A

Additional materials: Optical Answer Sheet (OAS)

Total Time For Booklets A & B : 1 h 45 min

Name : _____ ()

Class : Primary 4 / _____

Date : 29 October 2020

Maths Teacher: _____

INSTRUCTIONS TO CANDIDATES

DO NOT TURN OVER THIS PAGE UNTIL YOU ARE TOLD TO DO SO.

FOLLOW ALL INSTRUCTIONS CAREFULLY.

ANSWER ALL THE QUESTIONS.

SHADE YOUR ANSWERS IN THE OPTICAL ANSWER SHEET (OAS) PROVIDED.

Questions 1 to 15 carry 2 marks each. For each question, four options are given. One of them is the correct answer. Make your choice (1, 2, 3 or 4). Shade the correct oval (1, 2, 3 or 4) on the Optical Answer Sheet. (30 marks)

1. In which of the following numbers does the digit 9 stand for 900?

- (1) 9408
- (2) 8904
- (3) 8094
- (4) 4089

2. 23 thousands and 8 tens is the same as _____.

- (1) 238
- (2) 2380
- (3) 23 080
- (4) 23 800

3. Which of the following is **not** an equivalent fraction of $\frac{1}{4}$?

- (1) $\frac{3}{12}$
- (2) $\frac{2}{8}$
- (3) $\frac{5}{25}$
- (4) $\frac{4}{16}$

4. Which of the following mixed numbers is represented by the letter X in the number line shown?

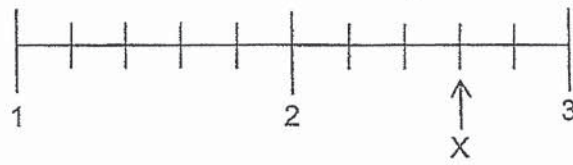

- (1) $2\frac{4}{6}$
- (2) $2\frac{2}{5}$
- (3) $2\frac{3}{5}$
- (4) $2\frac{3}{4}$
5. Arrange the following decimals from the smallest to the greatest.

6.7 , 0.76 , 6.07 , 0.67

- (smallest) (greatest)
- (1) 0.67 , 0.76 , 6.07 , 6.7
- (2) 0.76 , 0.67 , 6.07 , 6.7
- (3) 0.67 , 6.7 , 6.07 , 0.76
- (4) 0.76 , 0.67 , 6.7 , 6.07

6. One of the lines in the figure is parallel to EF. Which line is parallel to EF?

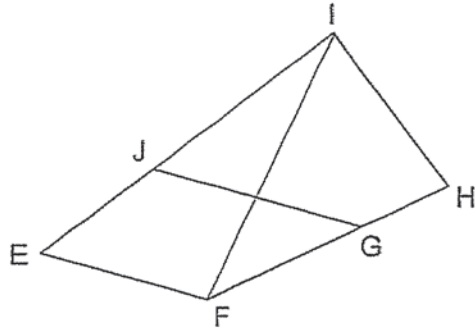

- (1) FH
- (2) IF
- (3) IH
- (4) JG

7. In the figure below, which angle is greater than a right angle?

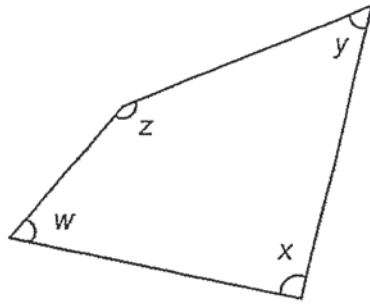

- (1) $\angle w$
- (2) $\angle x$
- (3) $\angle y$
- (4) $\angle z$

8. In the figure below, ABCD is a rectangle. $\angle BAF = 35^\circ$ and $\angle DAE = 30^\circ$.

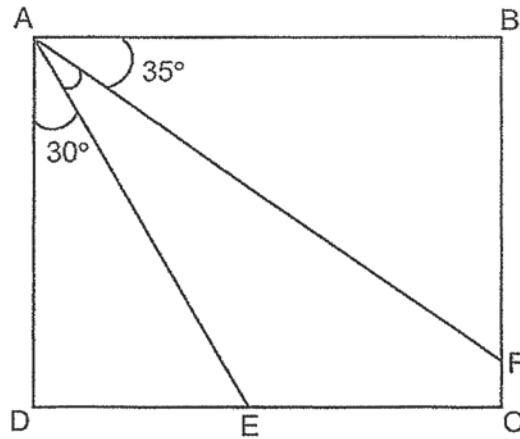

Find $\angle EAF$.

- (1) 5°
(2) 15°
(3) 25°
(4) 65°
9. Which of the following is the best estimate of the mass of a Shaping Maths Activity Book?
- (1) 4000 g
(2) 400 g
(3) 40 g
(4) 4 g
10. 72 children participated in a Lantern Making Competition. $\frac{3}{4}$ of them were girls. How many girls participated in the competition?
- (1) 54
(2) 48
(3) 24
(4) 18

11. Mrs Lam took 3 h 10 min to clean her house. Mr Veera took 55 min less than Mrs Lam to clean his house. They started cleaning at the same time at 1.15 p.m. What time did Mr Veera finish cleaning his house?
- (1) 3.30 p.m.
(2) 4.10 p.m.
(3) 4.25 p.m.
(4) 5.20 p.m.

12. The table below shows the different types of food that a group of adults like.

	Chicken Rice	Roti Prata	Nasi Lemak	Spaghetti
Men	13	11	14	4
Women	8	6	9	12

How many more adults like Nasi Lemak than Chicken Rice?

- (1) 1
(2) 2
(3) 6
(4) 7
13. Mandy writes a whole number on a card. The number is between 40 and 60 and it is a multiple of 6. If she adds 12 to the number, it will be a multiple of 5 and 10. What is the whole number that Mandy writes on the card?
- (1) 42
(2) 48
(3) 54
(4) 60

14. Farmer Ling planted 8 seedlings in a row. The seedlings were planted at the same distance apart. The distance between every two seedlings was 32.4 cm.

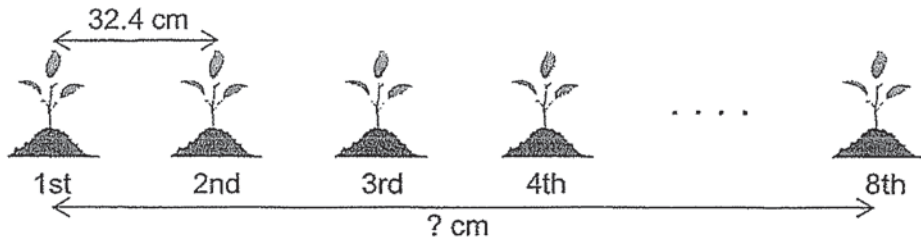

What was the distance between the first and the eighth seedling?

- (1) 113.4 cm
 - (2) 129.6 cm
 - (3) 226.8 cm
 - (4) 259.2 cm
15. The figure ABCDEFG below is made up of 2 rectangles. $AB = 8$ cm, $AG = 12$ cm and the perimeter of the figure is 70 cm.

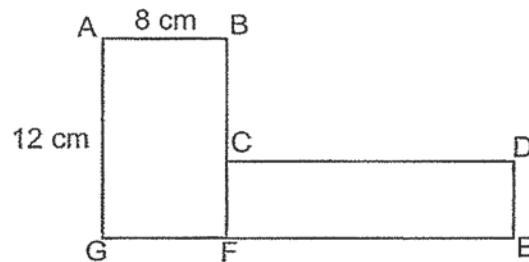

What is the length of CD?

- (1) 15 cm
- (2) 19 cm
- (3) 25 cm
- (4) 30 cm

PEI CHUN PUBLIC SCHOOL
End-of-Year Examination, 2020

MATHEMATICS
PRIMARY 4

BOOKLET B

Total Time For Booklets A & B : 1 h 45 min

Name : _____ ()

Class : Primary 4 / _____

Date : 29 October 2020

Maths Teacher: _____

Parent's Signature: _____

Booklet A	30
Booklet B	70
TOTAL	100

INSTRUCTIONS TO CANDIDATES

DO NOT TURN OVER THIS PAGE UNTIL YOU ARE TOLD TO DO SO.

FOLLOW ALL INSTRUCTIONS CAREFULLY.

ANSWER ALL QUESTIONS.

SHOW YOUR WORKING CLEARLY AS MARKS ARE AWARDED FOR CORRECT WORKING.

Questions 16 to 35 carry 2 marks each. Show your working clearly in the space below each question and write your answers in the spaces provided. For questions which require units, give your answers in the units stated. (40 marks)

Do not write
in this space

16. Round 32 450 to the nearest hundred.

Answer : _____

17. What is the remainder when 4197 is divided by 8?

Answer : _____

18. Some factors of 40 are 1, 2, 5, 8, 10 and 40. What are the other two factors of 40?

Answer : _____ and _____

19. Arrange the following fractions from the greatest to the smallest.

$\frac{1}{2}$, $\frac{2}{3}$, $\frac{7}{12}$

Answer : _____ , _____ , _____
(greatest) (smallest)

--

20. What fraction of the stars shown are shaded?



Answer : _____

21. Write the decimal represented by A.

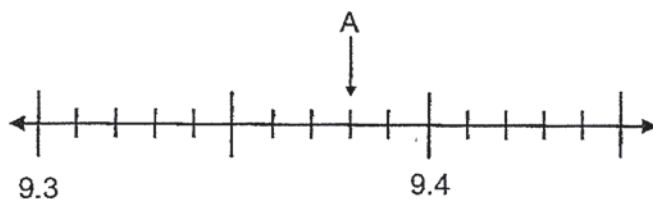

Answer : _____

22. Express $\frac{57}{100}$ as a decimal.

Answer : _____

23. $8.5 - 0.74 =$ _____

Answer : _____

Do not write
in this space

24. Measure and write down the size of $\angle x$.

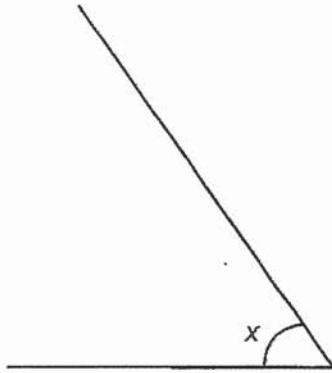

Answer : _____ °

25. In the square grid, PQ and QR are straight lines. PQ and QR form the sides of a rectangle PQRS. Complete the drawing of rectangle PQRS.

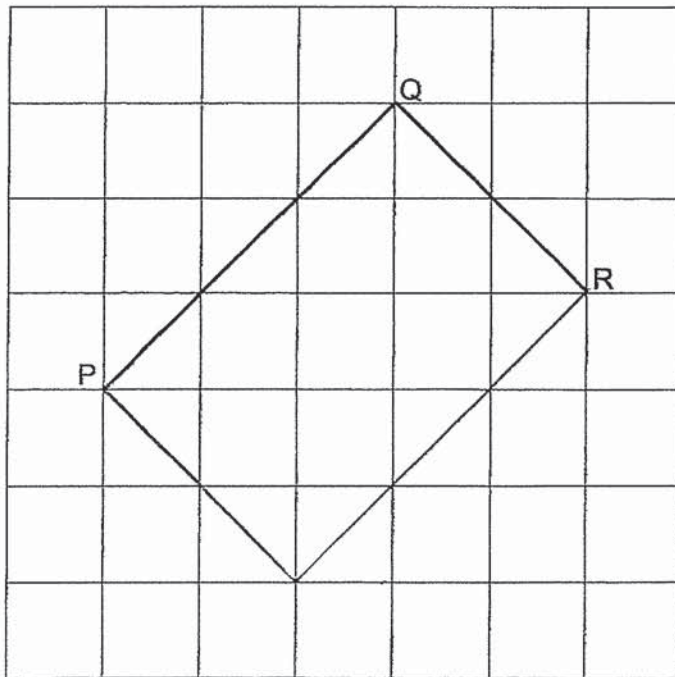

Do not write
in this space

26. In the figure below, the dotted line is the line of symmetry. What is the minimum number of squares needed to be shaded to make the figure symmetrical?

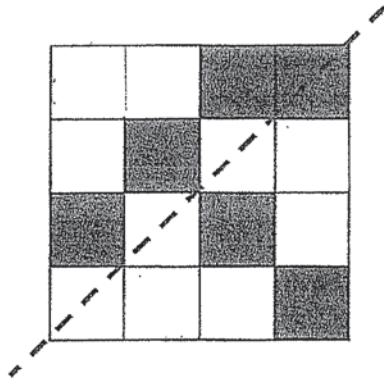

Answer : _____

27. The square grid shows the positions of points A, B, C, D and E.

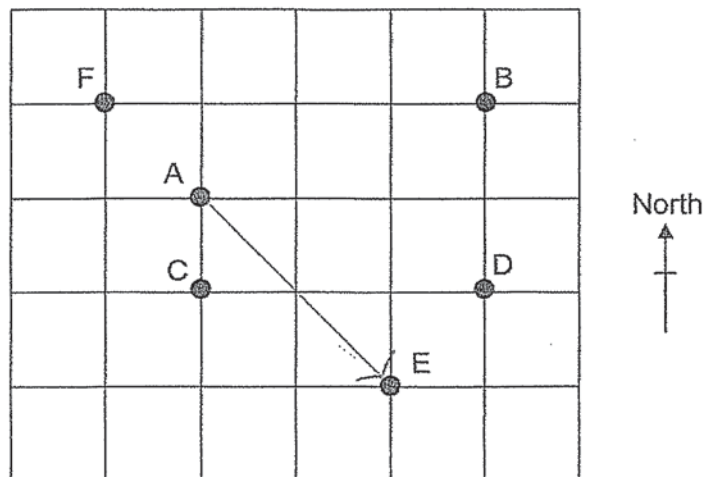

- (a) Which point is south-east of point A?
- (b) Mandy stood at a point facing south. She made a $\frac{3}{4}$ turn in a clockwise direction and ended up facing point D. Which point was Mandy at?

Answer : (a) Point _____

(b) Point _____

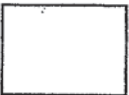

28. The diagram below shows the amount of water Miss Tay has prepared for her baking class. How much more water must she prepare to make 2 l? Give your answer in millilitres.

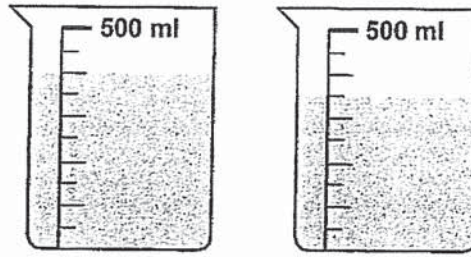

Answer : _____ ml

29. A picture measuring 11 cm by 9 cm is mounted on a rectangular cardboard leaving a border of 2 cm all around. What is the area of the rectangular cardboard?

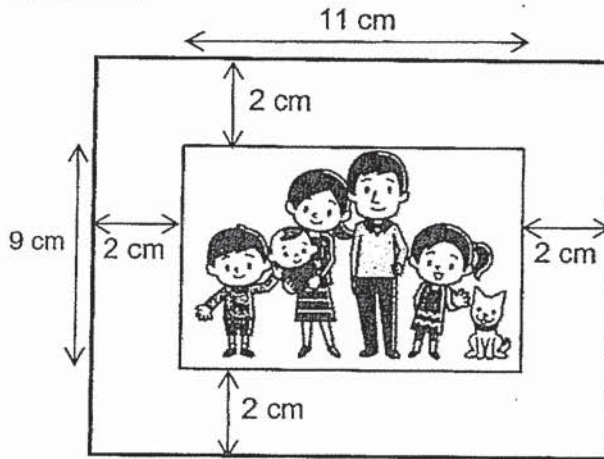

Answer : _____ cm²

30. Kathi bought a plant that was 6 cm tall. She measured the height of the plant in the evening every fifth day and recorded its height for 30 days. The line graph shows her records.

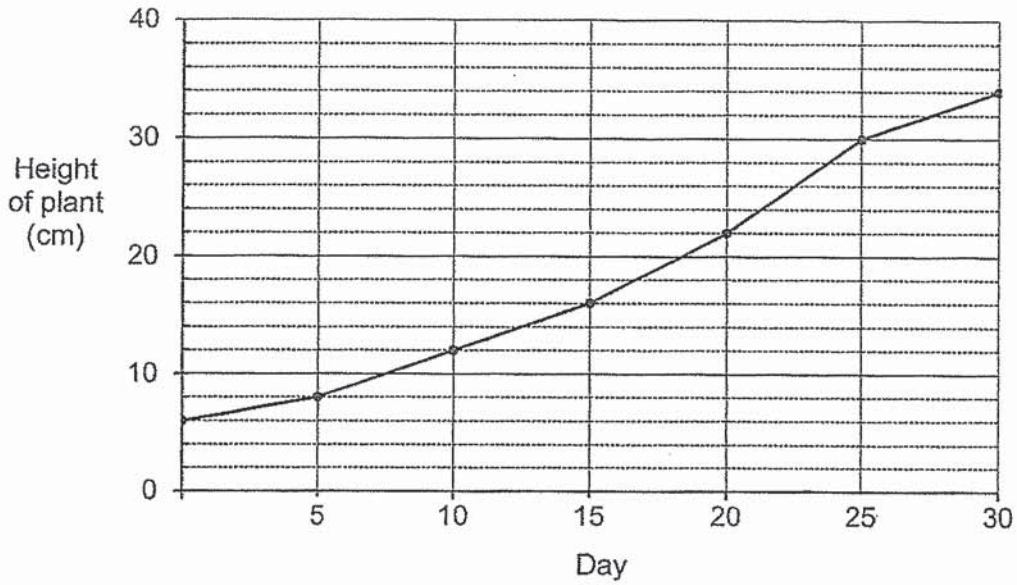

- (a) In which five-day period did the plant grow the most?
- (b) What was the increase in the height of the plant recorded from Day 10 to Day 15?

Answer : (a) Day _____ to Day _____

(b) _____ cm

31. Mrs Nurul and Mrs Wong had the same amount of money. After Mrs Nurul bought 3 kg of prawns, she had \$17.90 left. Mrs Wong needed \$29.60 more to buy 8 kg of prawns. How much did 1 kg of prawns cost?

Answer : \$ _____

32. A supermarket has a special offer on soda drinks.

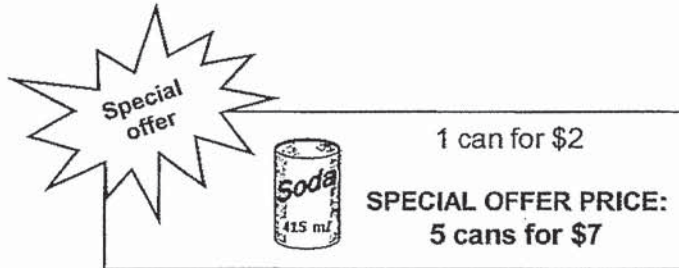

Zena buys 106 cans of soda drinks. What is the least amount of money she needs to pay?

Answer : \$ _____

33. Mr Tong bought a shirt with $\frac{2}{5}$ of his money. Then he bought a wallet which cost \$15 more than the shirt. He had \$90 left. How much money did Mr Tong have at first?

Answer : \$ _____

34. A rectangular piece of paper is shaded on one side. It is folded to form a shape as shown below. Find the perimeter of the rectangular piece of paper before it was folded.

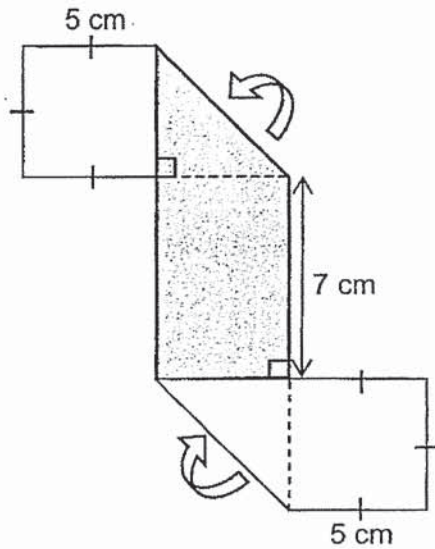

Answer : _____ cm

--

35. The graph below shows the mass of a cup when different combinations of objects A, B and C are placed in the cup.

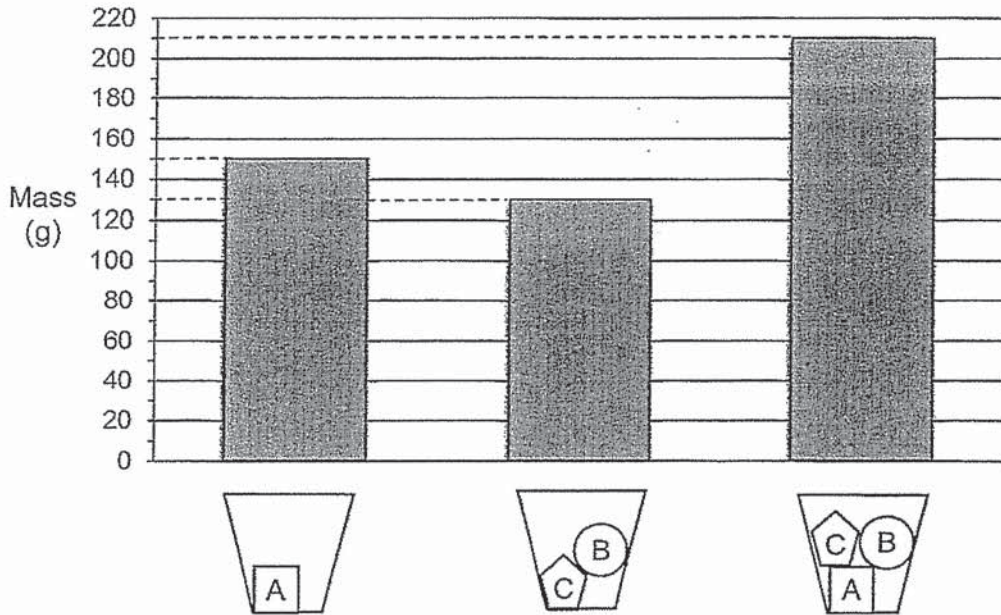

Based on the bar graph above, read the statements and put a tick (✓) in the correct box.

Statements	True	False	Not Possible to Tell
(a) The mass of the cup is 70 g.			
(b) Object A is the heaviest.			

SCORE

For questions 36 to 43, show your working clearly and write your answers in the spaces provided. The number of marks available is shown in brackets [] at the end of each question or part-question. (30 marks)

36. Noraini used $1\frac{5}{6}$ m of a piece of cloth to make a dress. She made a shirt which required $\frac{3}{4}$ m less cloth than the dress.

- (a) How much cloth did she use for making the shirt?
- (b) How much cloth did she use altogether?
Give your answer in its simplest form.

Answer : (a) _____ [2]

(b) _____ [2]

SCORE

37. In the figure below, ABCD is a rectangle and X is a square of area 81 cm^2 .

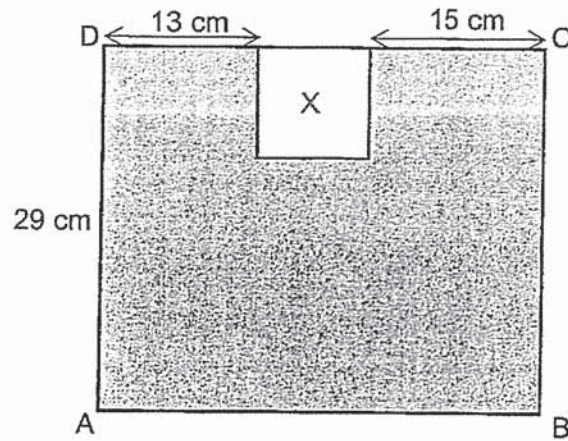

- (a) What is the length of AB?
(b) What is the area of ABCD?

Answer : (a) _____ [2]

(b) _____ [1]

Do not write
in this space

38. Mrs Mun baked some tarts and packed them into boxes of 4. She packed 592 boxes in all.

- (a) How many tarts did Mrs Mun bake?
- (b) Mrs Mun sold all the boxes of tarts except for 15 boxes. Each box of tarts was sold at \$6. How much money was collected from the sale of the tarts?

Answer : (a) _____ [2]

(b) _____ [2]

SCORE

39. The following are the entrance fees to Siloso Water Theme Park.
Use the information to answer the questions below.

Entrance Fees:

Weekdays	Weekend Family Package
Adult : \$23.60	2 Adults 2 Children : \$50.80
Child : \$11.80	Additional Adult : \$25.70
	Additional Child : \$13.90

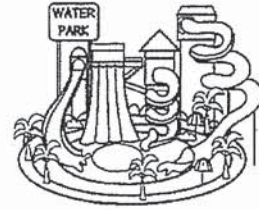

- (a) Mrs Johnson took her parents and 2 children to Siloso Water Theme Park on Saturday. How much entrance fees did she pay?
- (b) Mr Heng and his child went to Siloso Water Theme Park on Friday. He paid the cashier \$50 for the entrance fees and received some change. How much change did Mr Heng receive?

Answer : (a) _____ [2]

(b) _____ [2]

SCORE

40. Farah had 48 beads fewer than Emma at first. After Farah gave Emma 18 beads, Emma had three times as many beads as Farah. How many beads did Farah have at first?

Do not write
in this space

Answer : _____ [3]

41. The graph below shows the number of bottles of fruit juice sold in a week.

Do not write
in this space

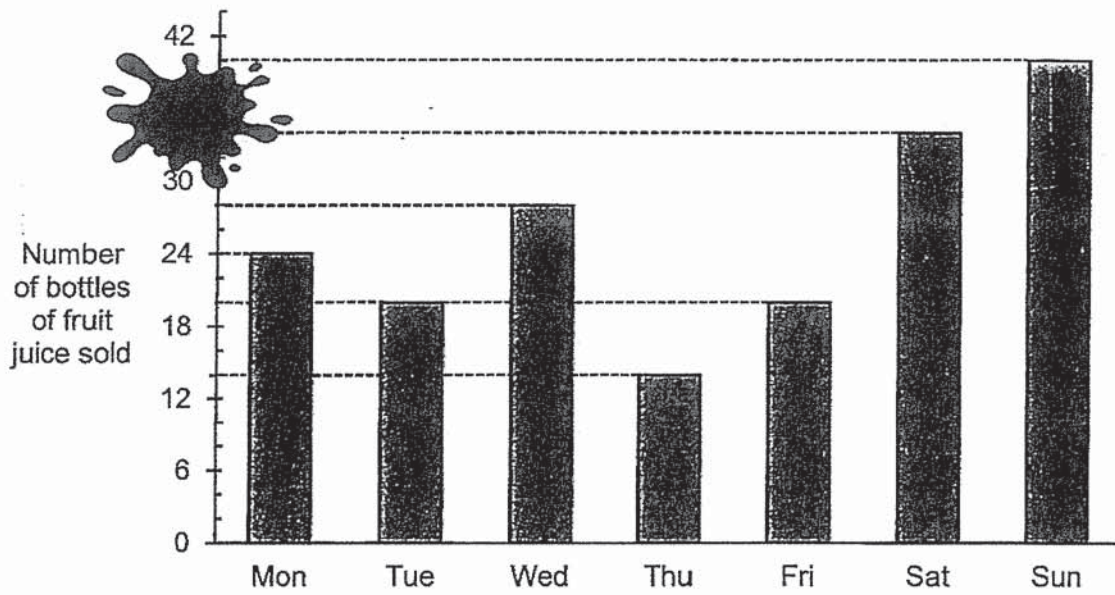

- (a) A blot of ink was accidentally dropped on the graph. How many bottles of fruit juice were sold on Sunday?
- (b) On which day was twice as many bottles of fruit juice sold as on Thursday?
- (c) Express the number of bottles of fruit juice sold on Monday as a fraction of the total number of bottles of fruit juice sold from Monday to Wednesday.

Answer : (a) _____ [1]

(b) _____ [1]

(c) _____ [2]

SCORE

42. The table shows the schedule of events at a carnival.

Do not write
in this space



Event	Starts at	Duration
Magic Show	11.30 a.m.	45 min
Treasure Hunt	1.00 p.m.	2 h 15 min
Horse Riding	2.05 p.m.	35 min
Colouring Competition	3.00 p.m.	1 h 20 min
Balloon Sculpting	3.20 p.m.	25 min

- (a) Joel wants to watch the Magic Show at 11.30 a.m. What time will the show end? Give your answer in the 12-hour clock.
- (b) Hui Ling will be at the carnival from 12.30 p.m. to 3 p.m. Which activity can she take part in?
- (c) Jumilah wants to take part in the Treasure Hunt and Balloon Sculpting. How much more time will she spend in Treasure Hunt than in Balloon Sculpting? Leave your answer in h and min.

Answer : (a) _____ [1]

(b) _____ [1]

(c) _____ [2]

43. The figure below is made up of 6 identical rectangles and a shaded rectangle ABCD. The area of ABCD is 189 cm^2 and $BC = 9 \text{ cm}$.

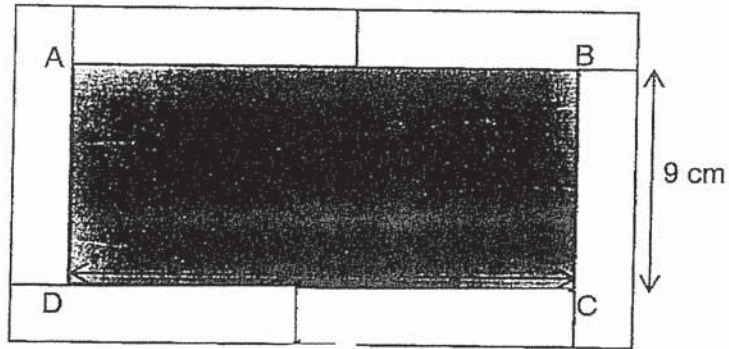

- (a) Find the length of CD.
 (b) Find the total area of the 6 identical rectangles.

Answer : (a) _____ [1]

(b) _____ [3]

End of Paper

Set by : Mrs Eileen Sew and Mrs Peggy Leong

SCORE

ANSWER KEY

YEAR: 2020

LEVEL: PRIMARY 4

SCHOOL: PEI CHUN PUBLIC SCHOOL

SUBJECT: MATHMATICS

TERM: END-OF-YEAR EXAMINATION

BOOKET A

Q1	2	Q2	3	Q3	3	Q4	3	Q5	1
Q6	4	Q7	4	Q8	3	Q9	2	Q10	1
Q11	1	Q12	2	Q13	2	Q14	3	Q15	1

BOOKLET B

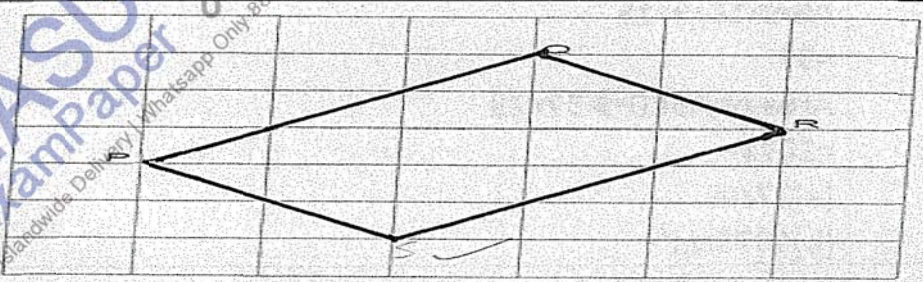
Q16	32500
Q17	remainder $\rightarrow 4197 \div 8$ 524R5 Ans: 5
Q18	4 and 20
Q19	$\frac{2}{3}, \frac{7}{12}, \frac{1}{2}$
Q20	$\frac{8}{11}$
Q21	9.38
Q22	0.57
Q23	7.76
Q24	55°
Q25	
Q26	3
Q27	(a) Point E (b) Point C
Q28	1250ml
Q29	Area $\rightarrow 13 \times 15$ $= 195 \text{cm}^2$

Q30	(a) Day 20 to Day 25 (b) 4cm
Q31	5kg \rightarrow 17.90+29.60 =47.50 1kg \rightarrow 47.50 \div 5 =\$9.50
Q32	Groups of 5 in 105 \rightarrow 105 \div 5 =21 105 \rightarrow 21 \times 7 =147 106 \rightarrow 147+2 =\$149
Q33	1 unit=90+15 =105 money at first \rightarrow 105 \times 5 =\$525
Q34	Perimeter \rightarrow 25+14+25 =64cm
Q35	(a) True (b) True
Q36	(a) $1\frac{5}{6} - \frac{3}{4} = 1\frac{10}{12} - \frac{9}{12} = 1\frac{1}{12}$ = $1\frac{10}{12} + 1\frac{1}{12}$ = $2\frac{11}{12}$ (b)
Q37	(a) Length of X \rightarrow 9 \times 9 =81 AB \rightarrow 13+9+15 =37 Area of ABCD \rightarrow 37 \times 29 =1073 (a) 37cm (b) 1073cm ²
Q38	(a) Tarts \rightarrow 592 \times 4 =2368 (b) Boxes sold \rightarrow 592-15 =577 Money \rightarrow 577 \times 6 =3462
Q39	(a) Pay \rightarrow 50.80+25.70 =76.50

	<p>(b) Mr Heng and Child $\rightarrow 23.60 + 11.80$ $= 35.40$ Change $\rightarrow 50 - 34.40$ $= 14.60$ (a) \$76.50 (b) \$14.60</p>
Q40	<p>2 units = $18 + 4 + 18$ $= 84$ 1 unit = $84 \div 2$ $= 42$ Farah = $42 + 18$ $= 60$</p>
Q41	<p>(a) 40 (b) Day $\rightarrow 14 \times 2$ $= 28$ (wednesday) (c) Mon to Wed $\rightarrow 24 + 20 + 28$ $= 72$ Fraction $\rightarrow \frac{24}{72}$</p>
Q42	<p>(a) 12.15 p.m. (b) Horse Riding (c) More time $\rightarrow 2\text{h}15\text{min} - 25\text{min}$ $= 1\text{h}75\text{min} - 25\text{min}$ $= 1\text{h}50\text{min}$</p>
Q43	<p>(a) CD $\rightarrow 189 \div 9$ $= 21$ (b) Breath of 1 rect. $\rightarrow 21 - 9 - 9$ $= 3$ Area of 1 small rect. $\rightarrow 12 \times 3$ $= 36$ Area of 6 small rect. $\rightarrow 36 \times 6$ $= 216\text{cm}^2$</p>

3

END.