

SINGAPORE CHINESE GIRLS' SCHOOL (PRIMARY)

SECOND SEMESTRAL ASSESSMENT 2020

NAME: _____ ()

DATE: 29 October 2020

CLASS: PRIMARY 3 / SY / C / G / SE / P

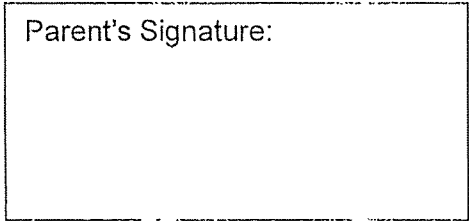
Parent's Signature:
**SCIENCE****BOOKLET A**

20 questions

40 marks

Total time for Booklets A & B: 1 h 25 min

**DO NOT OPEN THIS BOOKLET UNTIL YOU ARE TOLD TO DO SO.
FOLLOW ALL INSTRUCTIONS CAREFULLY.**

Part I (40 marks)

For each question from 1 to 20, four options are given.

One of them is the correct answer. Make your choice (1, 2, 3 or 4).

Shade the correct oval (1, 2, 3 or 4) on the Optical Answer Sheet.

1. The position of the sun in the sky changes. The sunflower turns to face the direction of the sun during the day.



Which of the following characteristics of living things explains this behavior?

- (1) Living things die.
 - (2) Living things grow.
 - (3) Living things reproduce.
 - (4) Living things respond to changes.
2. The things below are classified based on the characteristics R and S.

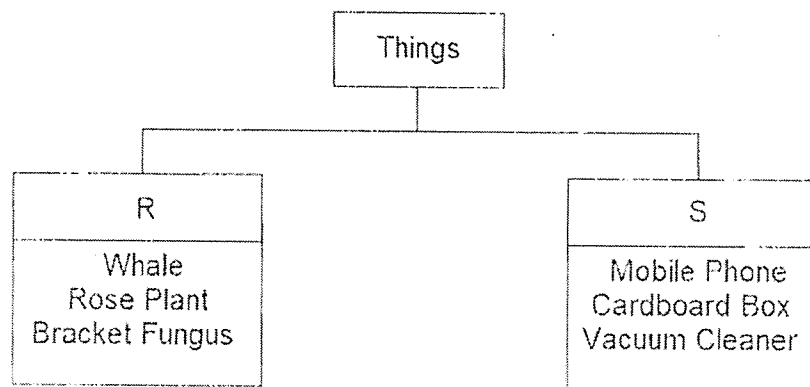

Which of the following correctly represents characteristics R and S?

	R	S
(1)	can make their own food	cannot make their own food
(2)	does not need water to survive	needs water to survive
(3)	can grow	cannot grow
(4)	cannot move on their own	can move on their own

3. The picture below shows a bat.

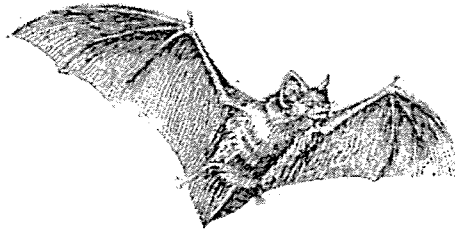

The table below shows the characteristics of 4 animals J, K, L and M.

Animal	Method of reproduction	Body covering
J	Gives Birth	Hair
K	Gives Birth	Scales
L	Lays eggs	Scales
M	Lays eggs	Feathers

Which of the animals J, K, L or M is the bat?

- (1) J
 - (2) K
 - (3) L
 - (4) M
4. Which of the following statements about bacteria is true?
- (1) All bacteria are harmful.
 - (2) All bacteria cannot reproduce.
 - (3) All bacteria make their own food.
 - (4) All bacteria cannot be seen with our naked eye.
5. Which of the following statement/s is/are true about the saliva in our mouth?
- A: Saliva cuts food into smaller pieces.
 - B: Saliva breaks down food into simpler substances.
 - C: Saliva softens food so it can be swallowed easily.
- (1) B only
 - (2) A and B only
 - (3) B and C only
 - (4) All of the above

6. Below shows a picture of a plant.

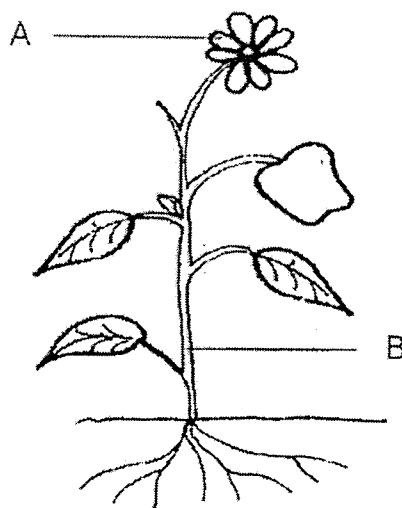

Which of the following show the names of parts A and B correctly?

	A	B
(1)	flower	stem
(2)	leaf	flower
(3)	flower	leaf
(4)	stem	leaf

7. The chart below shows how some plants are classified into two groups.

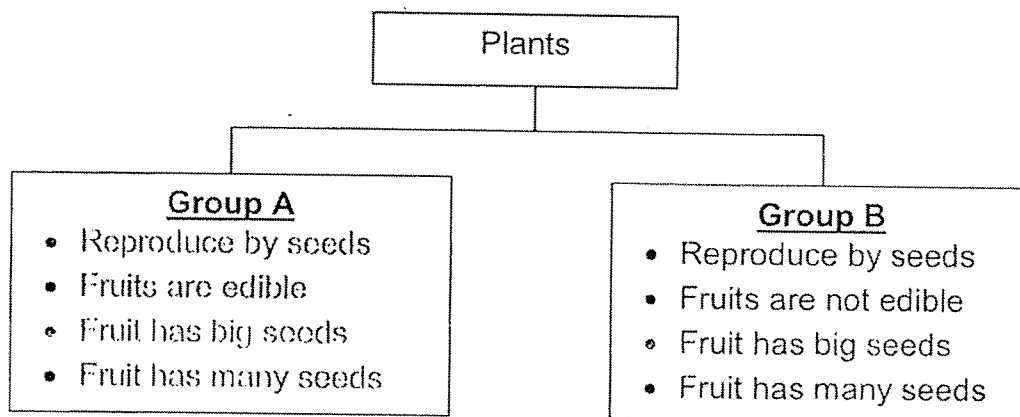

How are these plants grouped?

	Group A	Group B
(1)	Has edible fruits	Has inedible fruits
(2)	Reproduce by seeds	Reproduce by spores
(3)	Fruits with big seeds	Fruits with small seeds
(4)	Fruits with few seeds	Fruits with many seeds

8. The human digestive system is shown in the figure below.
Which one of the following correctly identifies the small intestine?

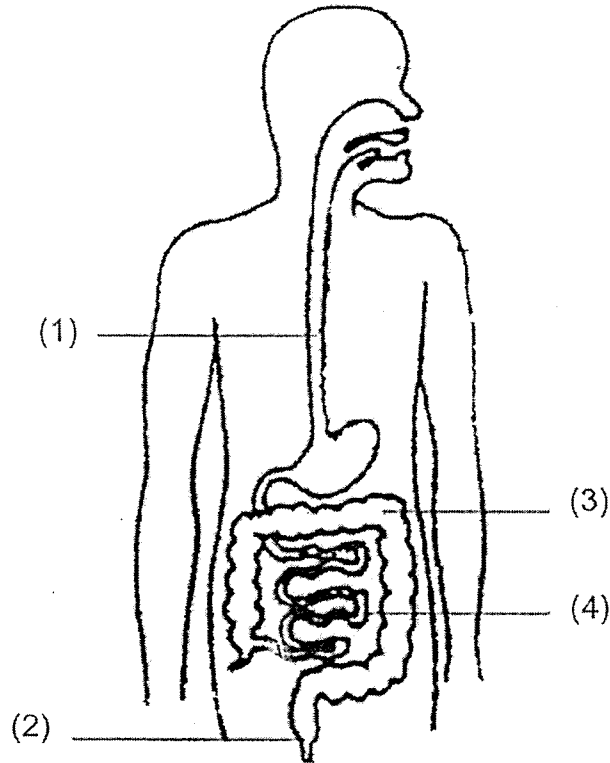

9. What is the function of the circulatory system?
- (1) It carries digested food, water and oxygen to all parts of the body.
 - (2) It supports the body and protects the organs.
 - (3) It breaks down food into simpler substances and absorbs them.
 - (4) It helps the body to exchange gases with the surroundings.
10. Amy wants to know if an animal is a reptile or a fish.
Which of the following questions should she ask to determine this?

Questions	
A	Does it swim?
B	Does it lay eggs?
C	Does it have gills?

- (1) A only
- (2) C only
- (3) A and B only
- (4) A and C only

11. Study the chart and classification table below.

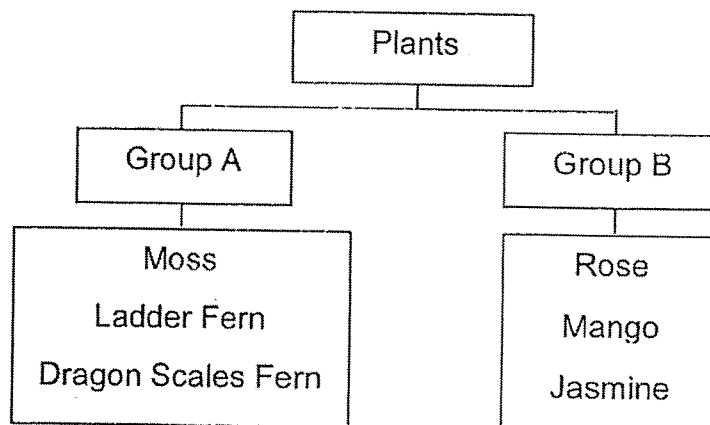

Which group does the bird's nest fern and water lily belong to in the chart above?

	Bird's Nest Fern	Water Lily
(1)	A	A
(2)	A	B
(3)	B	A
(4)	B	B

12. Some materials have been classified in the table below.

W	X	Y
Iron Clay Sand	Cotton Rubber Wood	Leather Wool Silk

Which of the following shows the correct headings X, Y and Z?

	W	X	Y
(1)	From plants	From animals	From the ground
(2)	From animals	From the ground	From plants
(3)	From the ground	From animals	From plants
(4)	From the ground	From plants	From animals

13. Danielle placed a cork ball (C) and a metal ball (M) into a beaker of water. She observed that the positions of the two balls were different. Which of the following correctly shows Danielle's observations?

(1)

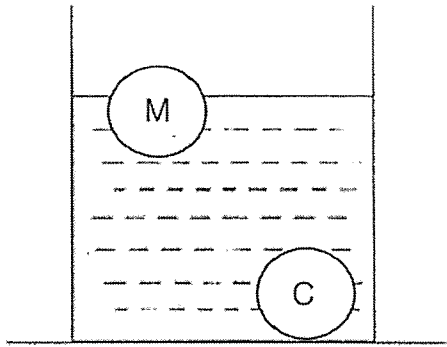

(3)

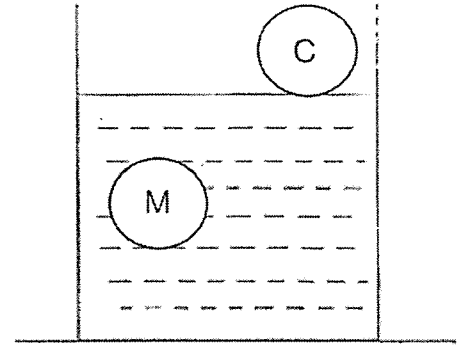

(2)

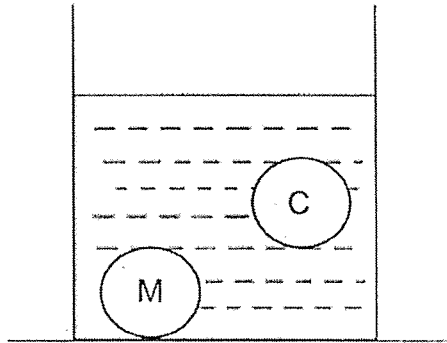

(4)

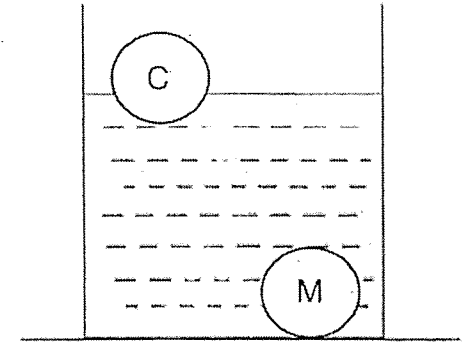

14. Four magnets are placed close to some pins. The number of pins attracted by each magnet is counted and recorded in the table below.

Magnet	Distance away from pins (cm)	Number of pins attracted
A	3	7
B	6	9
C	11	9
D	6	7

Which is the strongest magnet?

- (1) A
 (2) B
 (3) C
 (4) D

15. Jana uses a bar magnet to attract some nails. She counts the number of nails on different parts of the magnet, R, S, T and U, and plots her findings on the graph below.

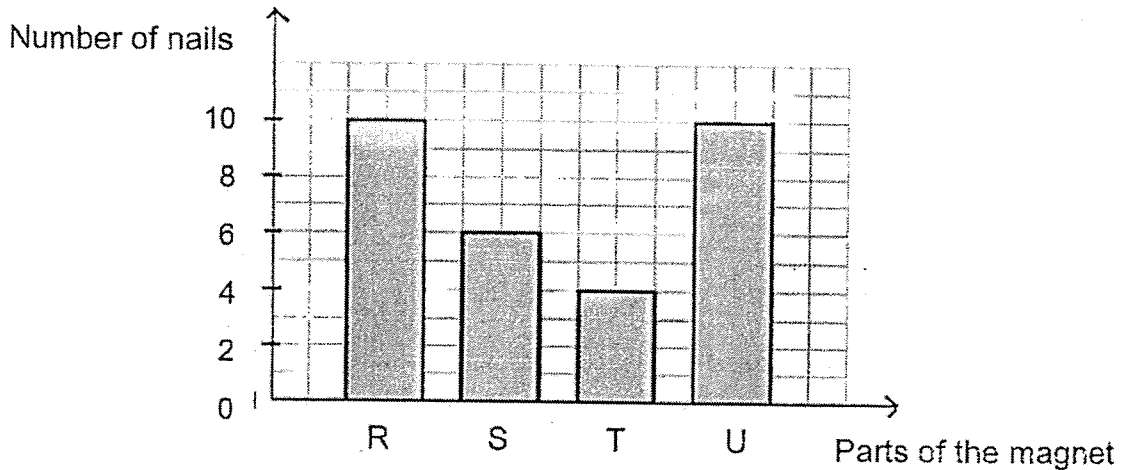

Which parts R, S, T or U are the poles of the magnet?

- (1) R and S
 (2) S and T
 (3) R and U
 (4) T and U
16. Study the set-ups below. In each of the set-ups, the number of paper clips attracted by the electromagnet is observed.

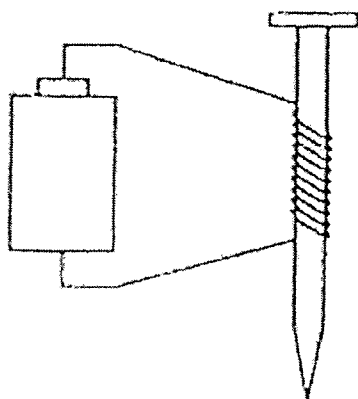

10 turns

Set-up E

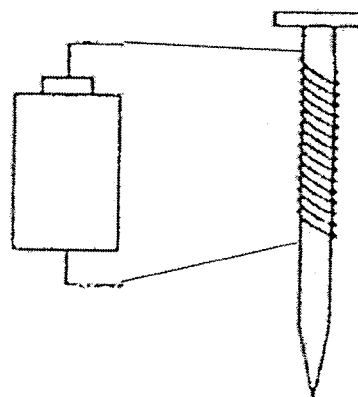

15 turns

Set-up F

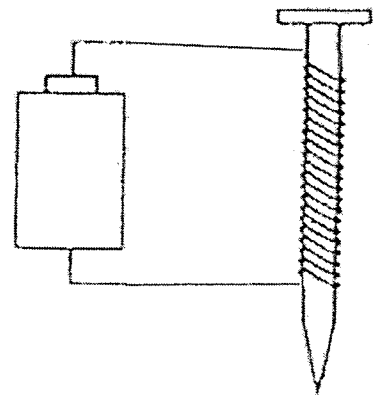

20 turns

Set-up G

Which of the following correctly shows the number of paper clips attracted by the electromagnets in set-ups E, F and G?

Number of Paper Clips Attracted by Electromagnet			
	E	F	G
(1)	18	6	12
(2)	6	12	18
(3)	18	12	6
(4)	12	18	6

17. If a freely-suspended magnet is allowed to come to rest, it will always point in a _____ direction.

- (1) North-East
- (2) North-South
- (3) East-West
- (4) West-North

18. Three ring magnets stayed apart when they were placed on top of one another.

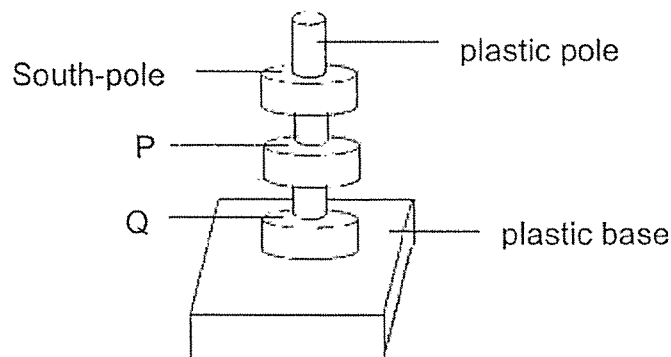

P is the _____ pole while Q is the _____ pole.

- (1) North , North
- (2) South , South
- (3) North , South
- (4) South , North

19. Mrs Lim is trying to separate 2 different types of materials in a glass container using a bar magnet. Which of the following sets of materials would she be able to separate using the magnet?

- (1) steel coin and iron filings
- (2) iron paper clips and paper strips
- (3) copper wire and wooden chips
- (4) aluminium rods and silver rings

20. Janice wants to conduct an experiment to find out if the number of batteries affect the strength of an electromagnet.

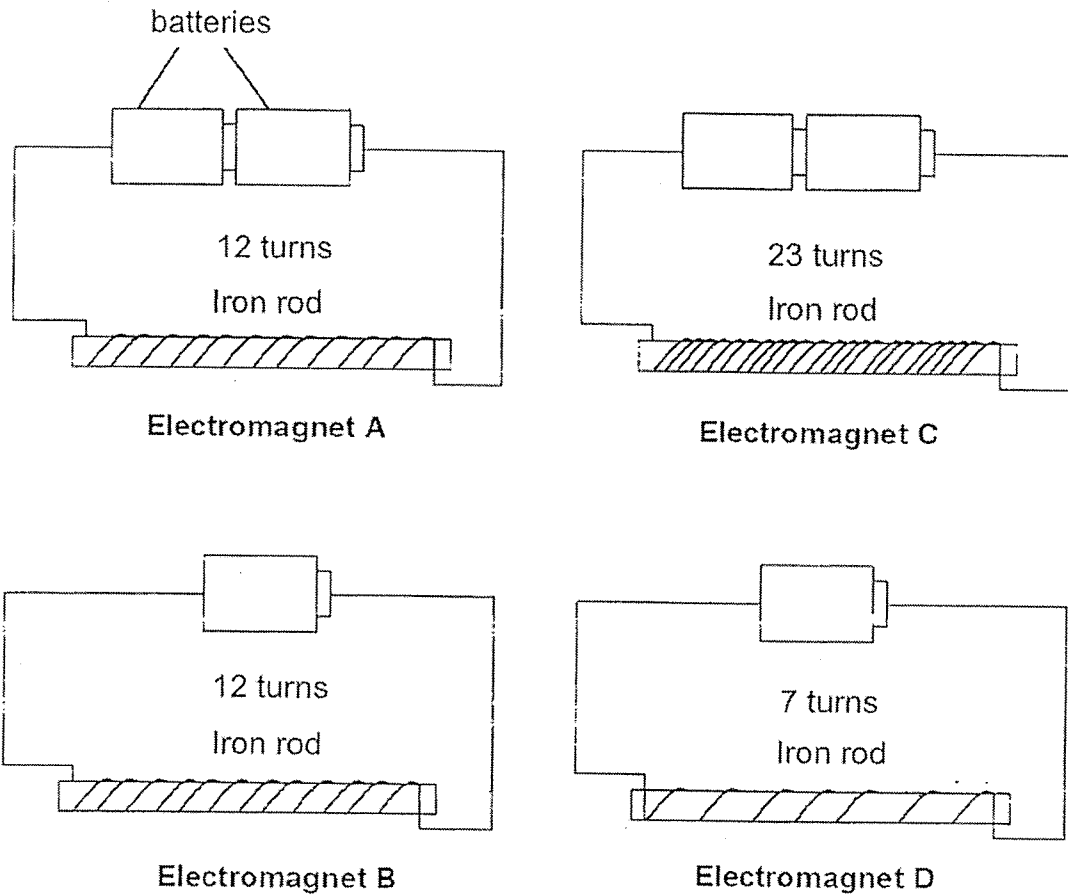

Which two electromagnets should she use for her experiment?

- (1) Electromagnets A and B
- (2) Electromagnets A and D
- (3) Electromagnets B and C
- (4) Electromagnets B and D

End of Booklet A

SINGAPORE CHINESE GIRLS' SCHOOL (PRIMARY)

SECOND SEMESTRAL ASSESSMENT 2020

NAME: _____ ()

DATE: 29 October 2020

CLASS: PRIMARY 3 SY / C / G / SE / P

Parent's Signature:

SCIENCE

BOOKLET B

	Total Actual Marks	Total Possible Marks
Booklet A		40
Booklet B		30
Total		70

8 questions

30 marks

Total time for Booklets A & B: 1 h 25 min

DO NOT OPEN THIS BOOKLET UNTIL YOU ARE TOLD TO DO SO.

FOLLOW ALL INSTRUCTIONS CAREFULLY.

Part II (30 marks)

Answer all the following questions.

21. Study the flowchart below carefully.

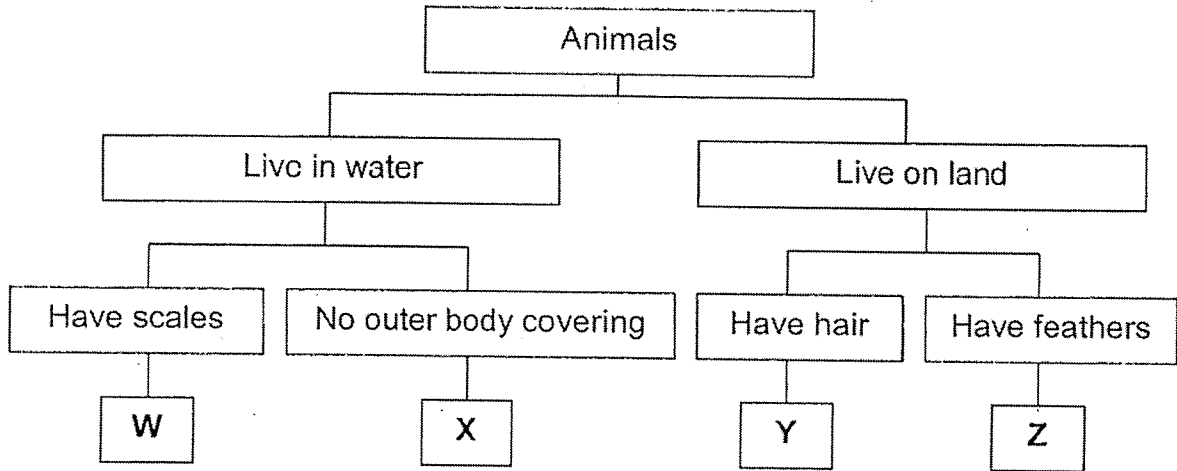

a) Describe Animal Y. (1m)

b) State one difference between Animal X and Animal Z. (1m)

c) Based on the table, which animals, W, X, Y or Z represents the animals below? (2m)

i) Goldfish : _____

ii) Parrot : _____

22. Study the experimental set-up below. Animal X eats flies.

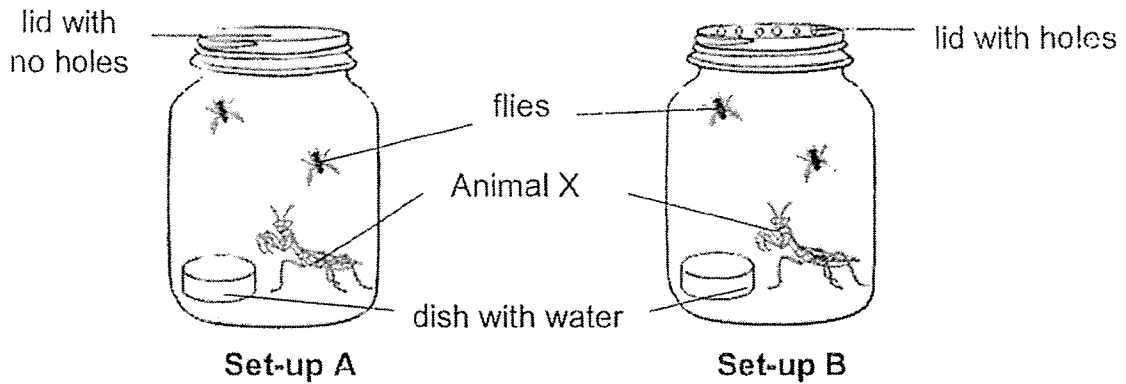

a) The above experiment was set up to find out if living things need _____ to stay alive. (1m)

b) What is likely to happen to Animal X in set-up A and set-up B after a week? (2m)

Set-up A : _____

Set-up B : _____

c) The experiment set-up below is used to show that living things need food to stay alive.

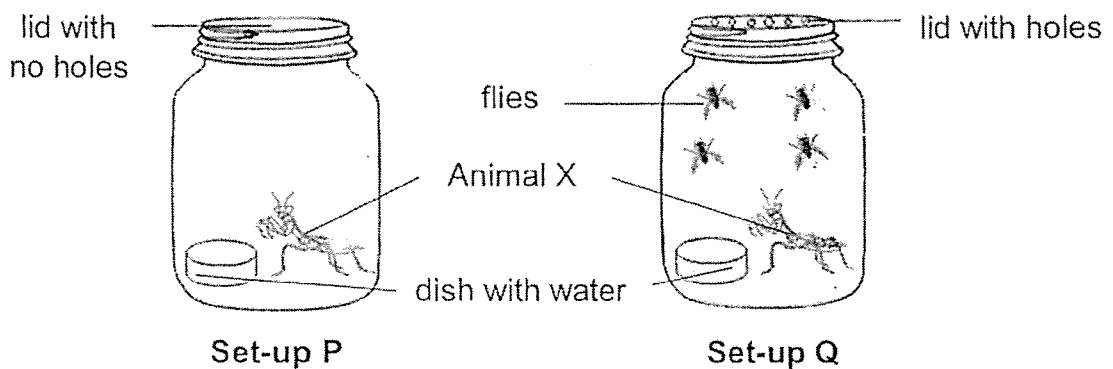

Why is this experiment not a fair test? (1m)

23. The diagram below shows plants P and Q.

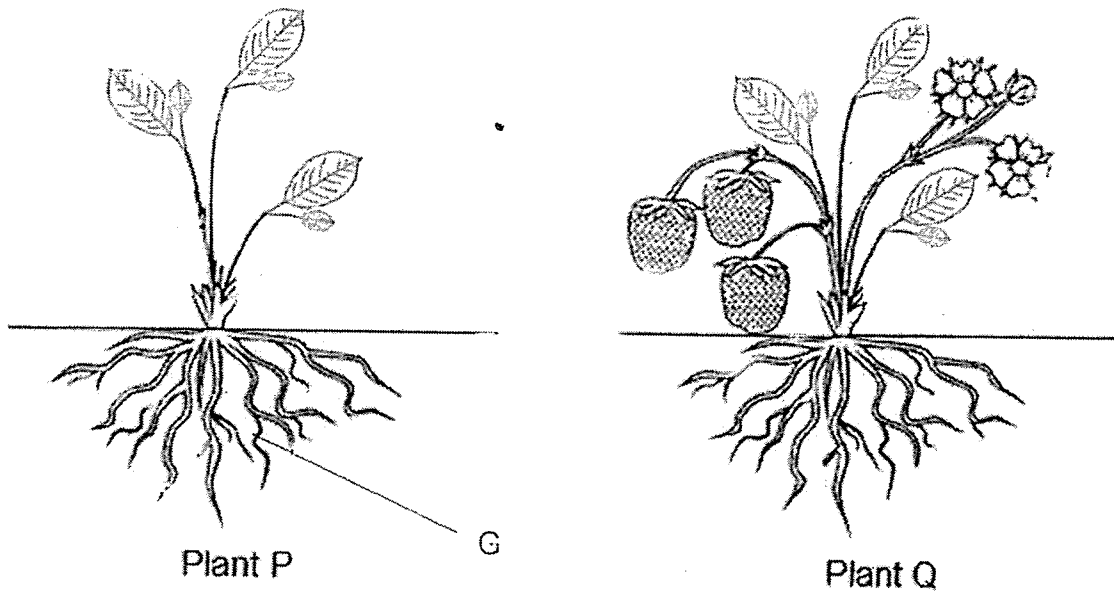

a) Based on what you can see only, state a similarity between plant P and plant Q. (1m)

b) Based on what you can see only, state a difference between plant P and plant Q. (1m)

c) State the function of part G. (1m)

24. Look at the picture of the mushroom below.

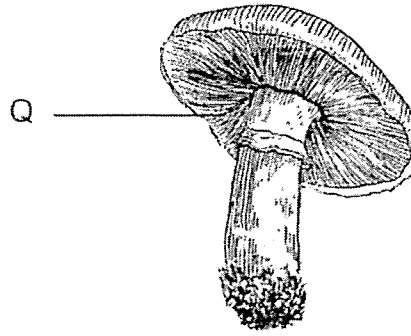

a) Part Q contains the _____ of the mushroom that helps it to reproduce. (1m)

b) Which group does the mushroom belong to? (1m)
Circle the correct answer.

Animal

Plant

Fungi

Bacteria

c) Name a type of plant that also reproduces the same way as the mushroom. (1m)

25a) Match the correct body system to its parts.

(4m)

Circulatory System ●

● Skull , Bones

Skeletal System ●

● Muscles

Muscular System ●

● Nose , Windpipe , Diaphragm , Lungs

Respiratory System ●

● Heart , Blood , Blood vessels

25b) The diagram below shows the human digestive system.

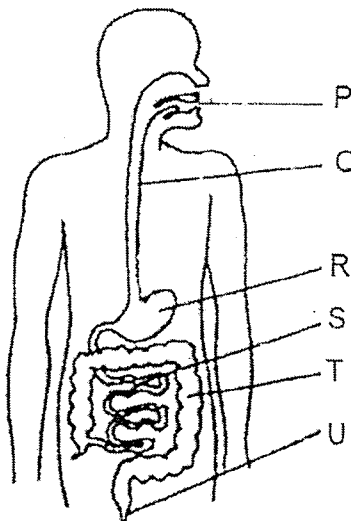

i) Part U is the _____ (1m)

ii) In which part/s of the digestive system, P, Q, R, S, T and/or U, are digestive juices produced? (1m)

iii) State the part of the digestive system where food is already completely digested. (1m)

26. The diagram below shows a plant.

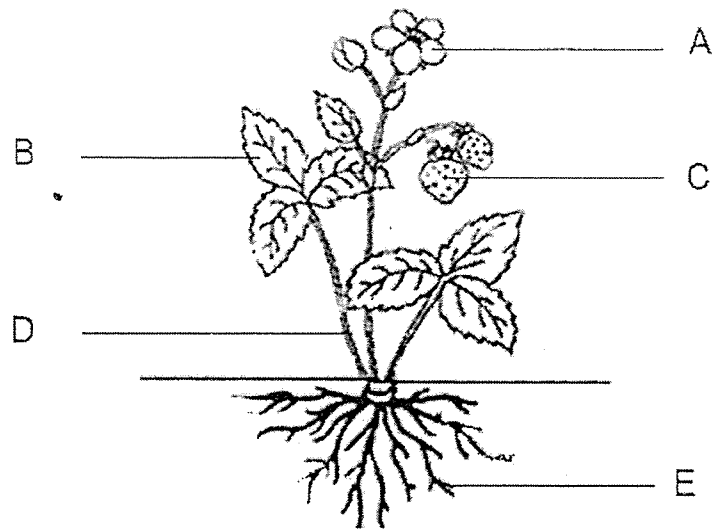

a) State the function of part B. (1m)

b) Which part, A, B, C, D or E, performs a similar function to the human skeletal system? (1m)

c) How is your answer in part (b) similar to the skeletal system? (1m)

27. Jane wants to make an umbrella that will shield the user from both the sun and the rain.

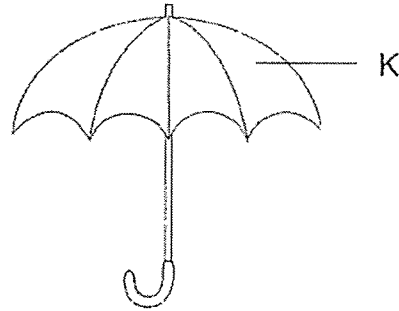

Tick (✓) the properties she should consider when choosing the material for making part K of the umbrella and put a cross (x) for properties she should not consider. (2m)

Property	Tick (✓) or Cross (x)
Flexible	
Waterproof	
Ability to Float	
Degree of Transparency	

28. The diagram below shows what happens when two bars are brought near each other.

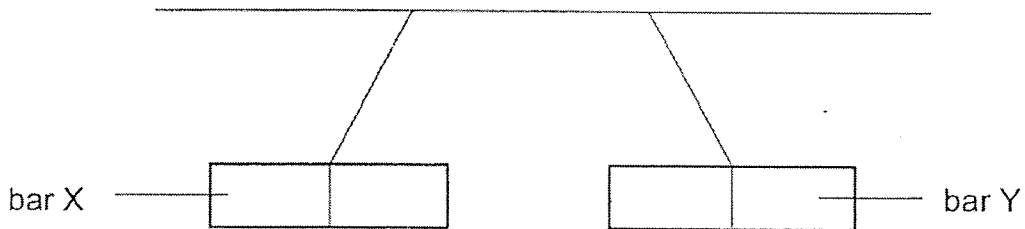

In the statements below, put a tick (✓) in the correct boxes to show if it is True, False or Not Possible to Tell. (4m)

	True	False	Not Possible to Tell
(i) Y is a magnet.			
(ii) X is a magnet.			
(iii) Y is made of steel.			
(iv) X is made of non-magnetic material.			

End of Booklet B

SINGAPORE CHINESE GIRLS' SCHOOL
2020 SA2 PRIMARY 3 SCIENCE

Part 1 (40m)

1.	4	6.	1	11.	2	16.	2
2.	3	7.	1	12.	4	17.	2
3.	1	8.	4	13.	4	18.	3
4.	4	9.	1	14.	3	19.	2
5.	3	10.	2	15.	3	20.	1

Part 2 (30m)

Qn No.	Suggested Answer
21a)	Animal Y lives on land and has hair.
21b)	Animal X has no outer body covering but Animal Z has / has feathers. OR Animal X lives in water but Animal Z lives on land / doesn't.
21c)	i) W ii) Z
22a)	Air
22b)	Set-up A: It would have died / no longer alive. Set-up B: It would still be alive.
22c)	Insect in Q has enough air / unlimited supply of air but insect in P does not.
23a)	Both have leaves / roots / stems. OR Both are land plants.
23b)	Plant Q has flowers / fruit but Plant P does not.
23c)	Take in / absorb water (and mineral salts) for the plant. OR Anchor / Hold the plant firmly to the ground / soil.
24a)	Spores
24b)	Fungi
24c)	Fern / Moss

Qn No.	Suggested Answer																				
25a)	<p>Circulatory System ● Skull, Bones Skeletal System ● Muscles Muscular System ● Nose, Windpipe, Diaphragm, Lungs Respiratory System ● Heart, Blood, Blood vessels</p>																				
25bi)	Anus																				
25bii)	P, R and S																				
25biii)	S / Small intestine																				
26a)	Makes food / photosynthesize for the plant OR Allows for gaseous exchange to take place for the plant																				
26b)	D																				
26c)	It supports the plant upright.																				
27)	<table border="1" style="width: 100%;"> <thead> <tr> <th>Property</th> <th>Tick (✓) or Cross (x)</th> </tr> </thead> <tbody> <tr> <td>Flexible</td> <td style="text-align: center;">✓</td> </tr> <tr> <td>Waterproof</td> <td style="text-align: center;">✓</td> </tr> <tr> <td>Ability to Float</td> <td style="text-align: center;">x</td> </tr> <tr> <td>Degree of Transparency</td> <td style="text-align: center;">✓</td> </tr> </tbody> </table>	Property	Tick (✓) or Cross (x)	Flexible	✓	Waterproof	✓	Ability to Float	x	Degree of Transparency	✓										
Property	Tick (✓) or Cross (x)																				
Flexible	✓																				
Waterproof	✓																				
Ability to Float	x																				
Degree of Transparency	✓																				
28)	<table border="1" style="width: 100%;"> <thead> <tr> <th></th> <th>T</th> <th>F</th> <th>NPTT</th> </tr> </thead> <tbody> <tr> <td>(i) Y is a magnet.</td> <td style="text-align: center;">✓</td> <td></td> <td></td> </tr> <tr> <td>(ii) X is a magnet.</td> <td style="text-align: center;">✓</td> <td></td> <td></td> </tr> <tr> <td>(iii) Y is made of steel.</td> <td></td> <td></td> <td style="text-align: center;">✓</td> </tr> <tr> <td>(iv) X is made of non-magnetic material.</td> <td></td> <td style="text-align: center;">✓</td> <td></td> </tr> </tbody> </table>		T	F	NPTT	(i) Y is a magnet.	✓			(ii) X is a magnet.	✓			(iii) Y is made of steel.			✓	(iv) X is made of non-magnetic material.		✓	
	T	F	NPTT																		
(i) Y is a magnet.	✓																				
(ii) X is a magnet.	✓																				
(iii) Y is made of steel.			✓																		
(iv) X is made of non-magnetic material.		✓																			