

Rosyth School
End-of-Year Examination 2020
SCIENCE
Primary 3

Total
Marks:

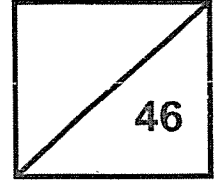

Name: _____

Class: Primary 3 _____

Register No. _____

Date: 3 November 2020

Total time for Booklets A and B: 1 h 30 min

Parent's Signature: _____

BOOKLET A



Instructions to Pupils:

1. Do not open the booklets until you are told to do so.
2. Follow all instructions carefully.
3. Answer all questions.
4. This paper consists of 2 booklets, Booklet A and Booklet B.
5. For questions 1 to 23 in Booklet A, shade the correct ovals on the Optical Answer Sheet (OAS) provided using a 2B pencil.

* This booklet consists of 16 printed pages (including cover page).

For each question from 1 to 23, four options are given. One of them is the correct answer. Make your choice (1, 2, 3 or 4). **Shade the correct oval (1, 2, 3 or 4) on the Optical Answer Sheet.** (46 marks)

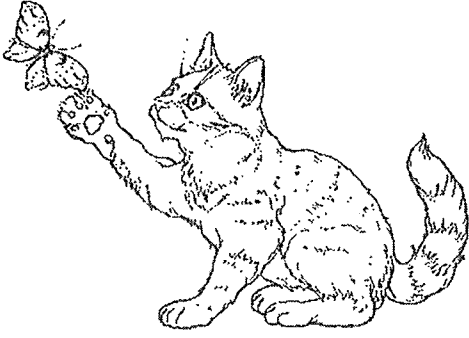
1. Which one of the following is a non-living thing?

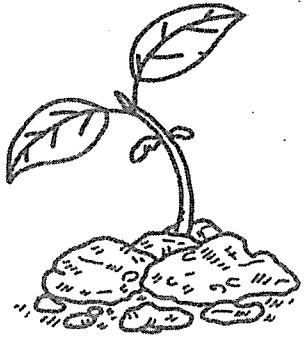
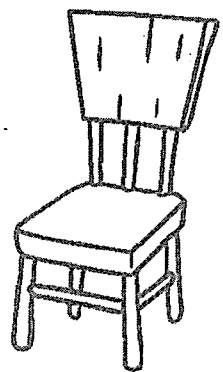
<p>(1) A cat catching a butterfly</p>  A line drawing of a cat sitting and reaching up with its right paw to catch a butterfly. The butterfly is perched on the cat's paw.	<p>(2) A bird eating a worm</p>  A line drawing of a bird, possibly a duck or goose, standing on the ground and eating a worm. The worm is on a small stick of earth.
<p>(3) A young plant growing</p>  A line drawing of a young plant with two leaves growing out of a pile of soil or rocks.	<p>(4) A wooden chair</p>  A line drawing of a simple wooden chair with a square seat and a high backrest.

2. Humans go through a difference in height as they age over the years as shown below.

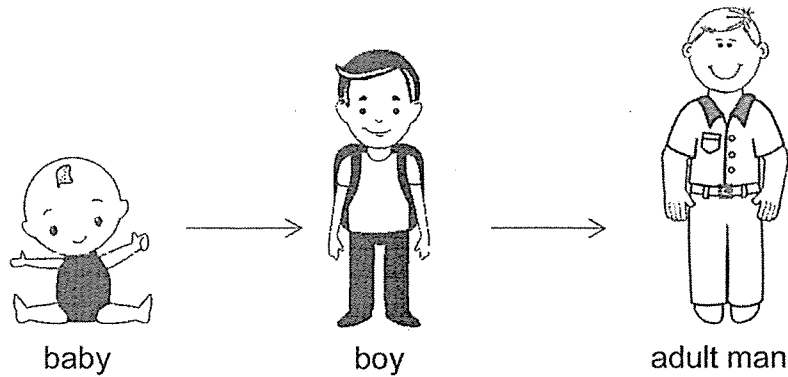

Which characteristic of living things does this difference in height show?

- (1) Living things die.
 - (2) Living things grow.
 - (3) Living things reproduce.
 - (4) Living things need air, food and water to survive.
3. Weiming observed a plant as shown below.

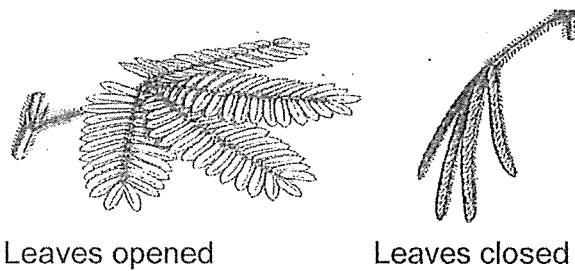

Which one of the following characteristics can help Weiming to decide if the plant is a living thing?

- A : Colour of leaves
 - B : Presence of leaves
 - C : Leaves are able to close on its own
 - D : Leaves start to wither and drop when not watered
- (1) A and B only
 - (2) C and D only
 - (3) A, C and D only
 - (4) A, B, C and D only

4. Which of the following is the outer covering for mammals?

- (1) hair
- (2) shell
- (3) scales
- (4) feathers

5. Study the classification chart below.

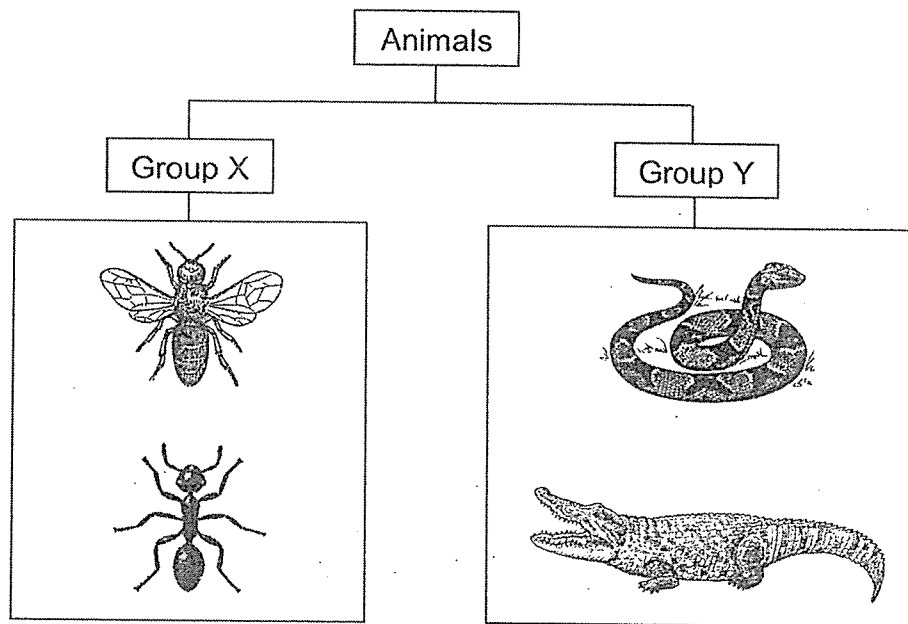

Which of the following set of headings best represents Group X and Y?

	Group X	Group Y
(1)	Have wings	Do not have wings
(2)	Do not have six legs	Have six legs
(3)	Do not have feelers	Have feelers
(4)	Have three body parts	Do not have three body parts

6. Mary saw a living thing in her garden. She described the characteristics of the living thing as shown below.

It reproduces from spores.
It cannot make its own food.

Which of the following groups of living things does it most likely belong to?

- (1) plant
- (2) animal
- (3) fungi
- (4) bacteria

7. Three students made the following statements about a body system.

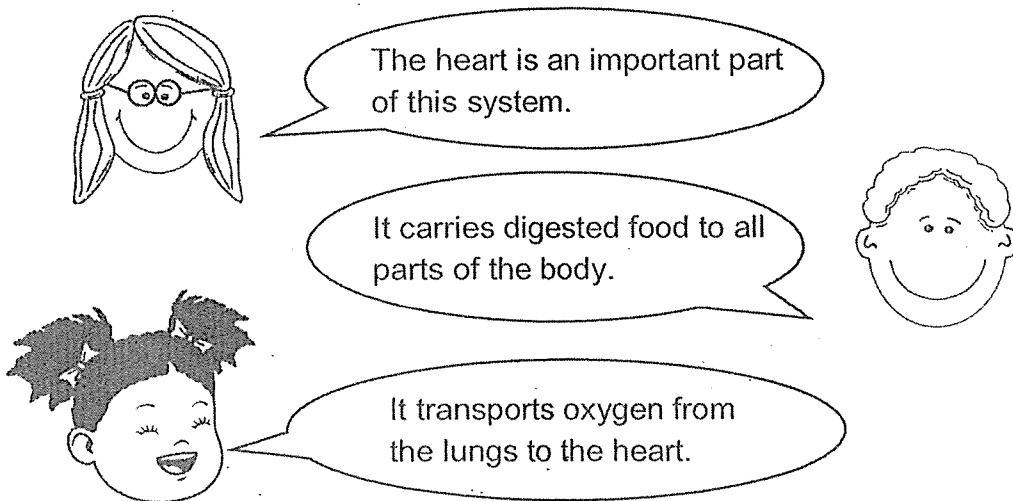

Which body system best represents the students' descriptions?

- (1) muscular system
- (2) digestive system
- (3) circulatory system
- (4) respiratory system

8. Study the body parts of a human shown below.

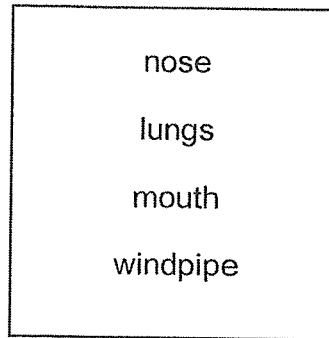

Which one of the following parts does not belong in the same body system?

- (1) nose
 - (2) lungs
 - (3) mouth
 - (4) windpipe
9. Wearing a mask to cover our mouth and nose is important in preventing the spread of viruses. If someone gets infected with a virus, one of the common symptoms is difficulty in breathing.

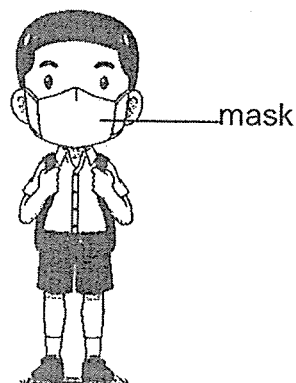

Which one of the body systems are we protecting through the use of masks?

- (1) skeletal system
- (2) muscular system
- (3) circulatory system
- (4) respiratory system

10. Part X helps in the process of digestion.

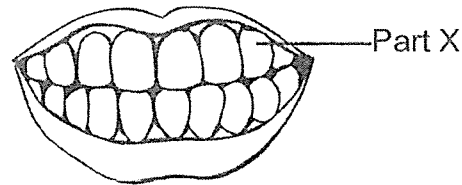

In what way does it help in the digestion of food?

- (1) It mixes the food with saliva.
- (2) It rolls the food into small balls.
- (3) It cuts the food into smaller pieces.
- (4) It breaks down the food into simpler substances.

11. Adam describes an organ in the digestive system as shown below.

I am a long tube in the digestive system. I work together with another system to push food for digestion. I do not produce any digestive juices.

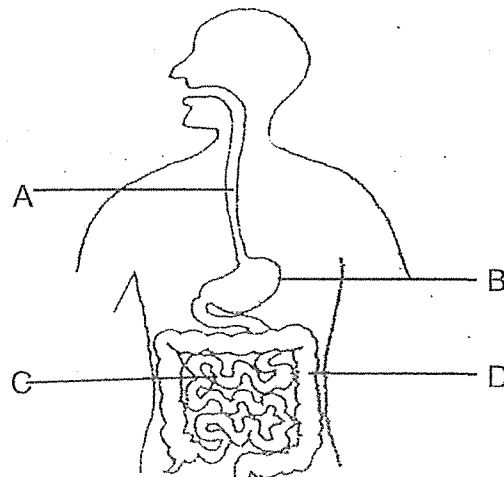

Which organ, A, B, C or D, best represents Adam's description?

- (1) A
- (2) B
- (3) C
- (4) D

12. Which one of the following graphs represent the amount of undigested food entering the small intestine and large intestine respectively?

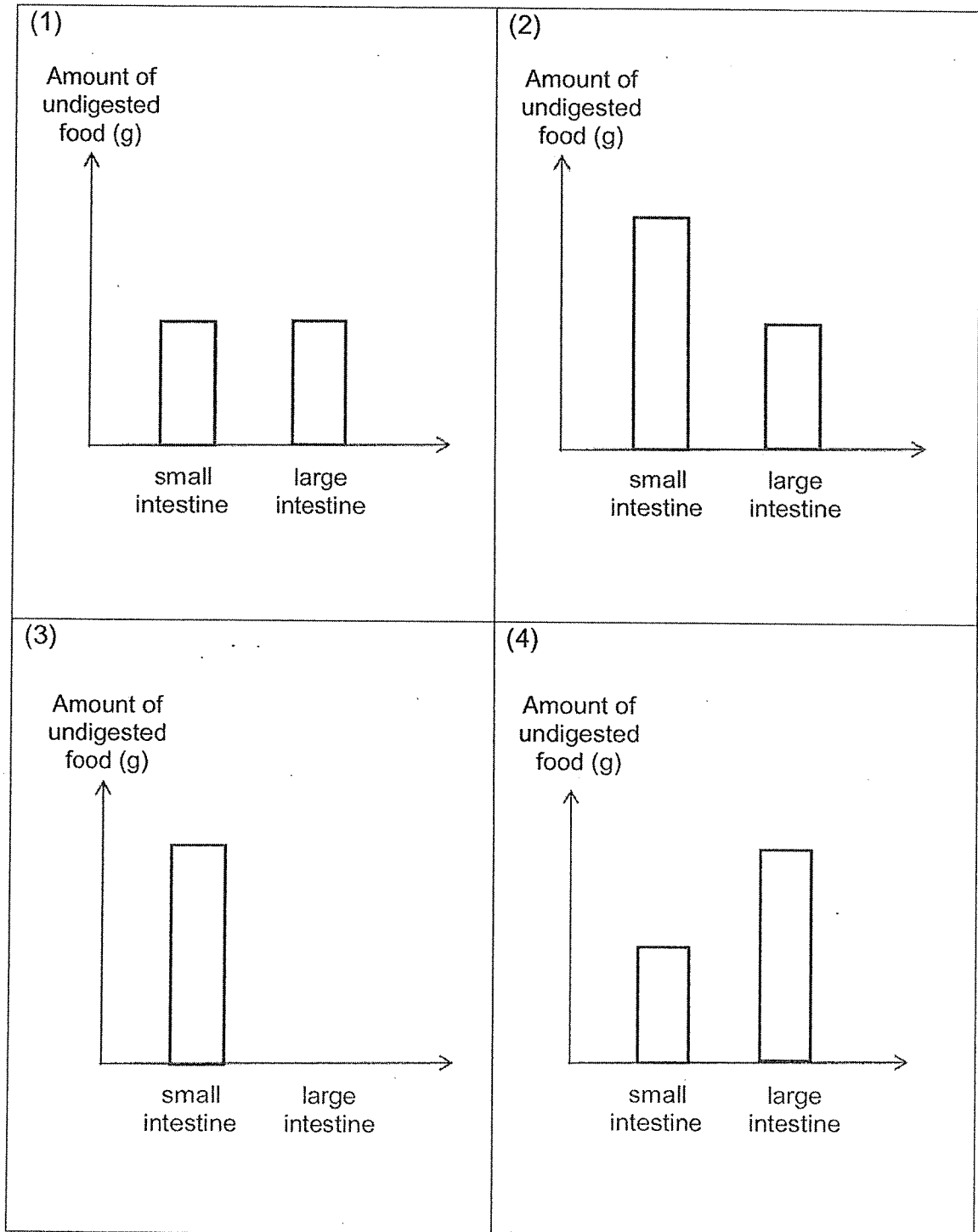

13. The graph below shows the amount of digested food in different parts of the digestive system.

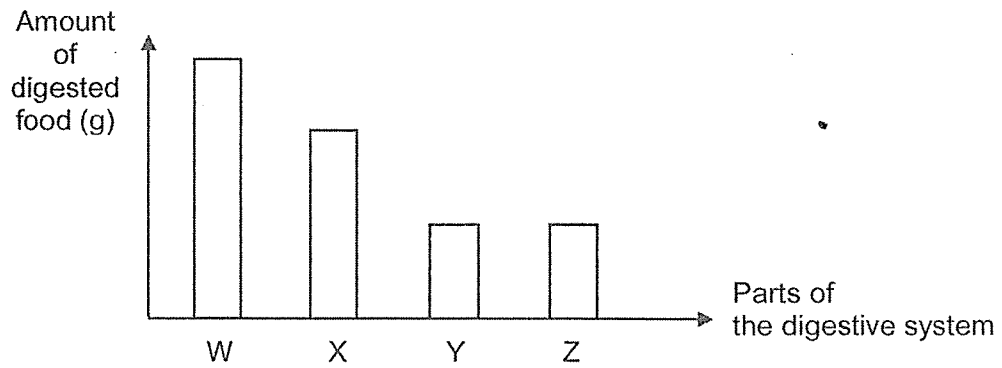

Which of the following diagrams matches the graph above?

<p>(1)</p> <p>Diagram (1) shows the human digestive system with labels: Z (mouth), Y (esophagus), X (stomach), and W (small intestine).</p>	<p>(2)</p> <p>Diagram (2) shows the human digestive system with labels: Y (mouth), Z (esophagus), W (stomach), and X (small intestine).</p>
<p>(3)</p> <p>Diagram (3) shows the human digestive system with labels: Y (mouth), W (esophagus), X (stomach), and Z (small intestine).</p>	<p>(4)</p> <p>Diagram (4) shows the human digestive system with labels: W (mouth), X (esophagus), Y (stomach), and Z (small intestine).</p>

14. Which of the following materials comes from plants?
- (1) clay
 - (2) wool
 - (3) cotton
 - (4) metal
15. Vinitha has four bags, each made of a different material. Each bag is able to hold objects up to a certain weight. The table below shows how much weight each bag can hold without breaking.

Bag	Amount of weight the bag can hold without breaking (kg)
A	6
B	8
C	2
D	10

Which bag should Vinitha use to carry an object weighing 9kg?

- (1) A
- (2) B
- (3) C
- (4) D

16. Philip conducted several tests on materials, A, B, C and D. He recorded his results in the table below.

A tick (✓) indicates the presence of the property and a cross (X) indicates the absence of the property.

Property	Materials			
	A	B	C	D
Waterproof	✓	✓	✓	X
Transparency	✓	✓	X	✓
Flexibility	✓	X	X	X

The picture below shows a car.

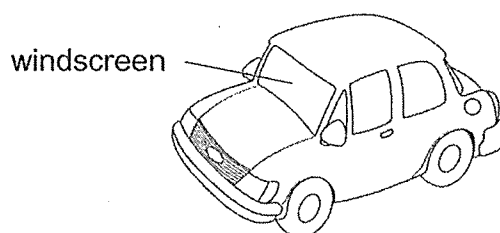

Based on Philip's test results, which is the most suitable material to make a car windscreen?

- (1) A
- (2) B
- (3) C
- (4) D

17. Siti wants to use a container to bring her pet hamster to the vet. Her mother reminds her to keep it in a container which has the following properties.

Properties of the container

- It is light.
- It is transparent.
- It does not break easily

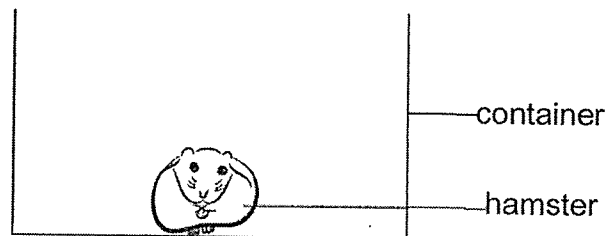

Which material should the container be made of?

- (1) plastic
 - (2) metal
 - (3) glass
 - (4) wood
18. A student tests several types of magnets.
- Which of the following observation could best help her compare the strengths of the different types of magnets?
- (1) The size of the magnets
 - (2) The weight of the magnets
 - (3) The shape of an object attracted by the magnets
 - (4) The distance at which an object is attracted to the magnets

19. When a bar magnet is cut into two pieces, as shown below.



You will get _____.

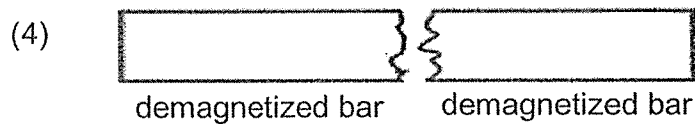
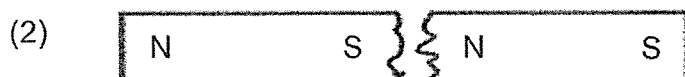
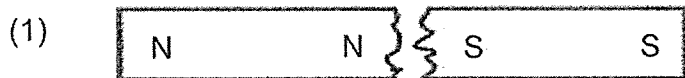

20. Kai Hui had two metal bars, Bar X and Bar Y. She placed both bars as shown below and made the observations.

In the first experiment, Bar Y moved towards Bar X.

First Experiment

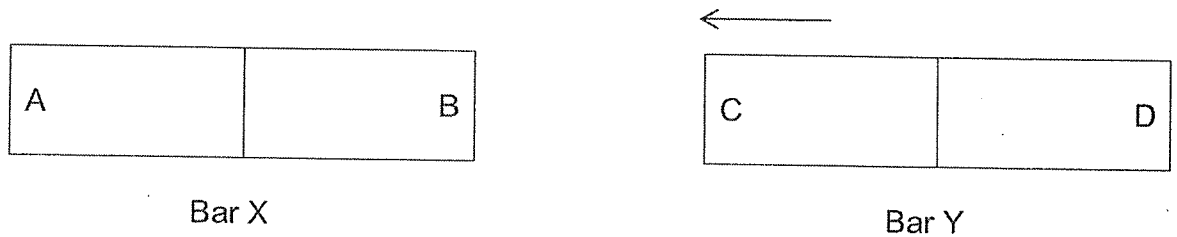

In the second experiment, she then flipped Bar X around and again, Bar Y moved towards Bar X.

Second Experiment

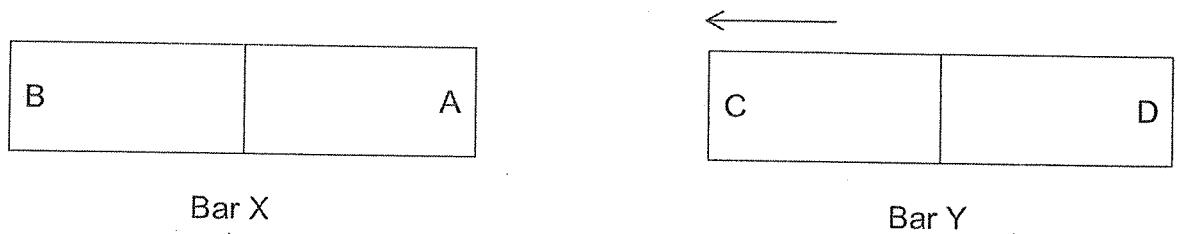

Which one of the following is true about the two metal bars?

- (1) Both X and Y are magnets.
- (2) Both X and Y are not magnets.
- (3) One is a magnet while the other is a magnetic bar.
- (4) One is a magnet while the other is a non-magnetic bar.

21. Ahmad carried out an experiment as shown below. In set-up A, there was no iron rod in the coils while there was an iron rod with coils in set-up B.

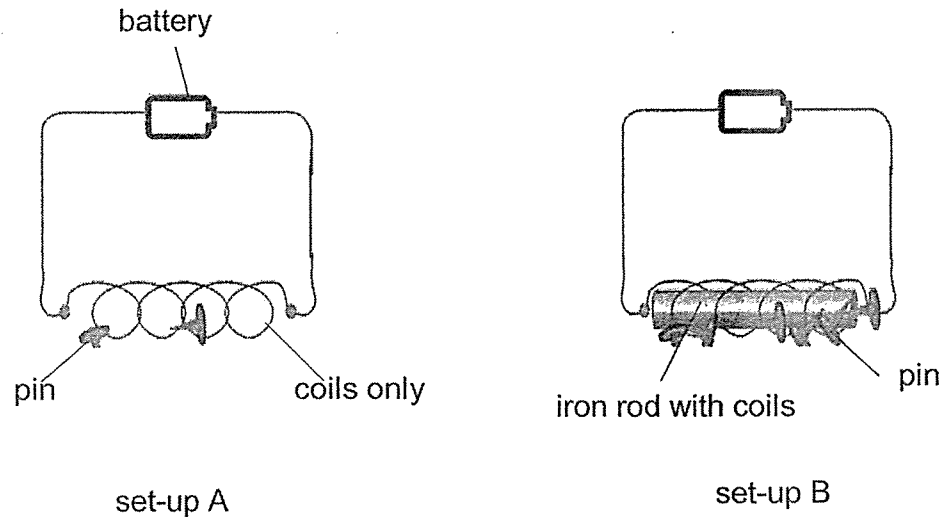

He changed the number of coils in both set-ups and measured the pins attracted. The results are recorded in a table as shown below.

Number of coils	Number of pins attracted	
	set-up A	set-up B
4	2	6
8	4	8
12	6	10

Based on results, which of the following is correct?

- (1) There is no magnetic strength when there is no iron rod.
- (2) There is magnetic strength only when there is an iron rod.
- (3) There is more magnetic strength when there is more coils.
- (4) There is more magnetic strength when there is more batteries.

22. The diagram below shows five teddy bears holding hands. There are magnets inside their hands.

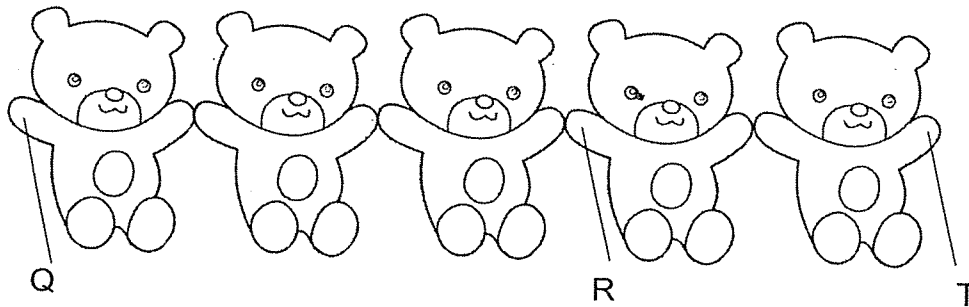

Based on the diagram above, which one of the following could represent the correct poles of Q, R and T?

	Q	R	T
(1)	north	north	south
(2)	north	south	south
(3)	south	north	north
(4)	south	south	south

23. Study the floating pot of plant as shown below.

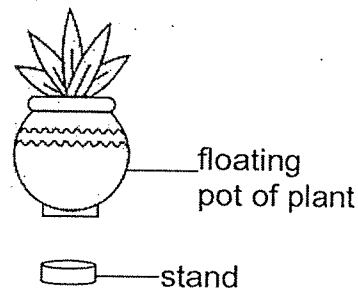

For the pot of plant to float, there must be a minimum of _____ magnet(s) at work.

- (1) one
- (2) two
- (3) three
- (4) four

(Go on to Booklet B)

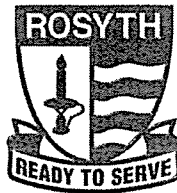

Rosyth School
End-of-Year Examination 2020
SCIENCE
Primary 3

**Total
Marks:**

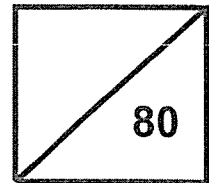

Name: _____

Class: Primary 3 _____

Register No. _____

Date: 3 November 2020

Total time for Booklets A and B: 1 h 30 min

Parent's Signature: _____

BOOKLET B

Instructions to Pupils:

1. For questions 24 to 34 give your answers in the spaces given in this booklet.

	Maximum	Marks Obtained
Booklet A	46 marks	
Booklet B	34 marks	
Total	80 marks	

* This booklet consists of 14 printed pages and 1 blank page (including cover page).

This paper is not to be reproduced in part or whole without the permission of the Principal.

For questions 24 to 34, write your answers in this booklet.

(34 marks)

24. Bala kept two hamsters in a cage over a period of time. He fed them with the same amount of food and water every day. The bar graph below shows the number of hamsters in the cage during the five months. No hamsters were added or removed from the cage.

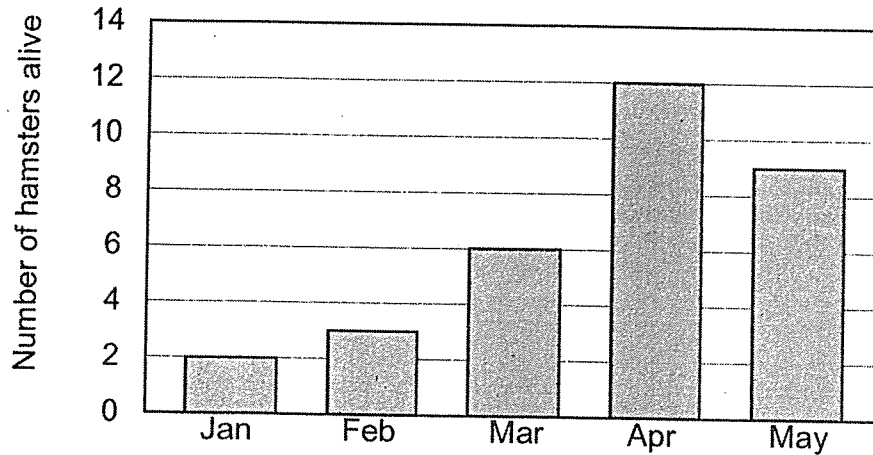

- (a) Based on the graph above, what do you notice about the number of hamsters from January to April? [1]

- (b) Why is there a change in the number of hamsters from Jan to Mar and from Apr to May respectively? [2]

Tick (✓) the correct reasons.

Reasons	Jan to Mar (Tick one box)	Apr to May (Tick one box)
• Living things die.		
• Living things reproduce.		
• Living things can grow.		
• Living things move from place to place.		

25. Study the flowchart below carefully.

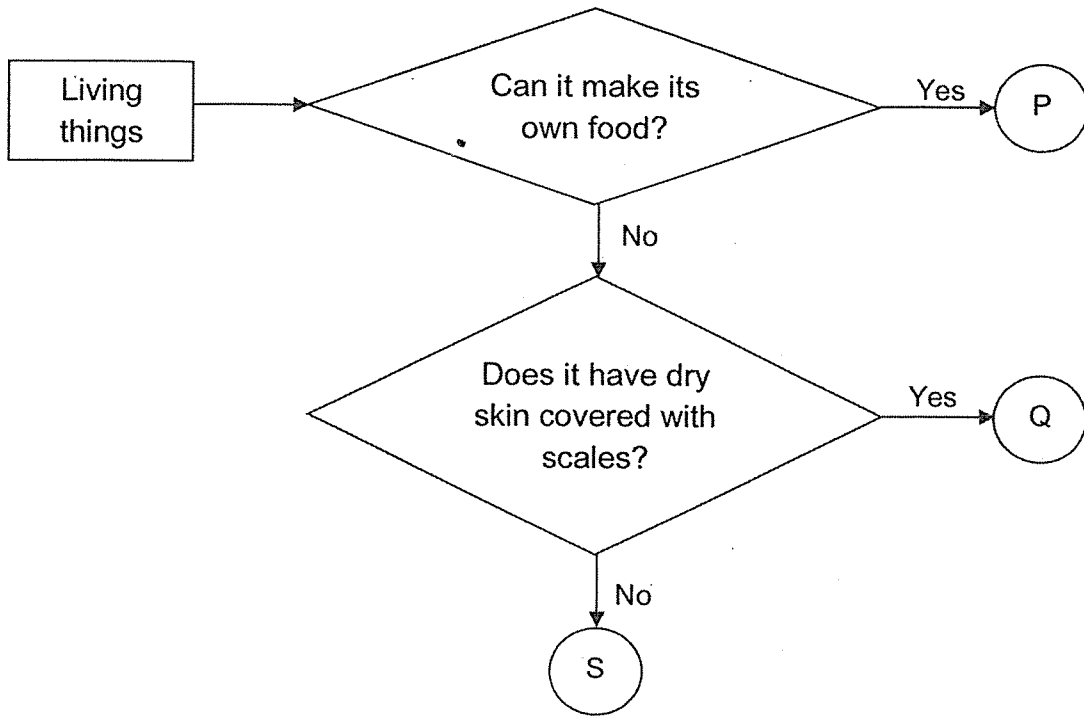

(a) State the characteristic of P. [1]

(b) State a difference between living things, Q and S. [1]

(c) Based on the flowchart, which letter, P, Q or S best represents the following animal groups? [1]

(i) Reptile :

(ii) Amphibian :

26. Susan saw some bird's nest ferns and mushroom at her garden as shown below.



bird's nest fern

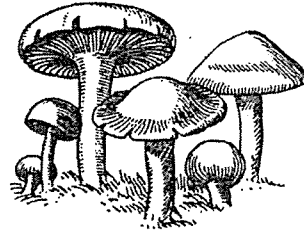

mushroom

She noticed some black spots at the underside of the fern and mushroom. Her teacher said that these black spots are important for their reproduction.

(a) What do you think these black spots are? [1]

(b) Which group of living things do fern and mushroom belong to? [1]

(i) Mushroom : _____

(ii) Bird's nest fern : _____

27. Jane held a string puppet as shown below. She moved the strings attached to the hands and legs of the puppet up and down to make it move.

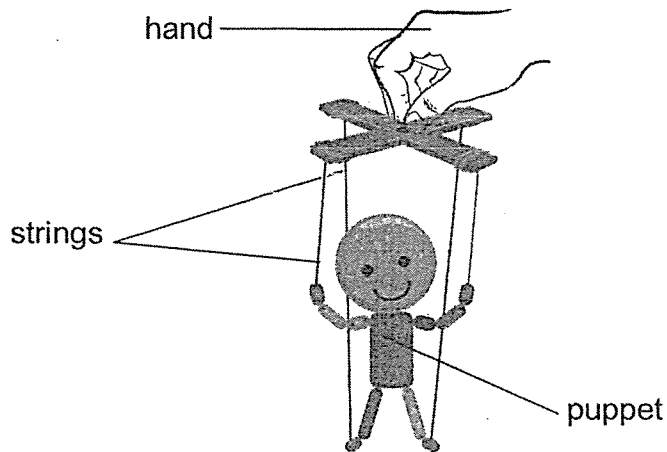

- (a) Which two human body systems work the same way as the string puppet to enable it to move? [2]

(i) _____

(ii) _____

- (b) Which of the following function/s is/are true about the human skeletal system? Put a tick (✓) in the correct boxes. [1]

Functions	Tick (✓) if correct
• It protects the skin.	
• It supports the body.	
• It gives the body a shape.	

28. The flow chart below shows the pathway of food in the human digestive system.

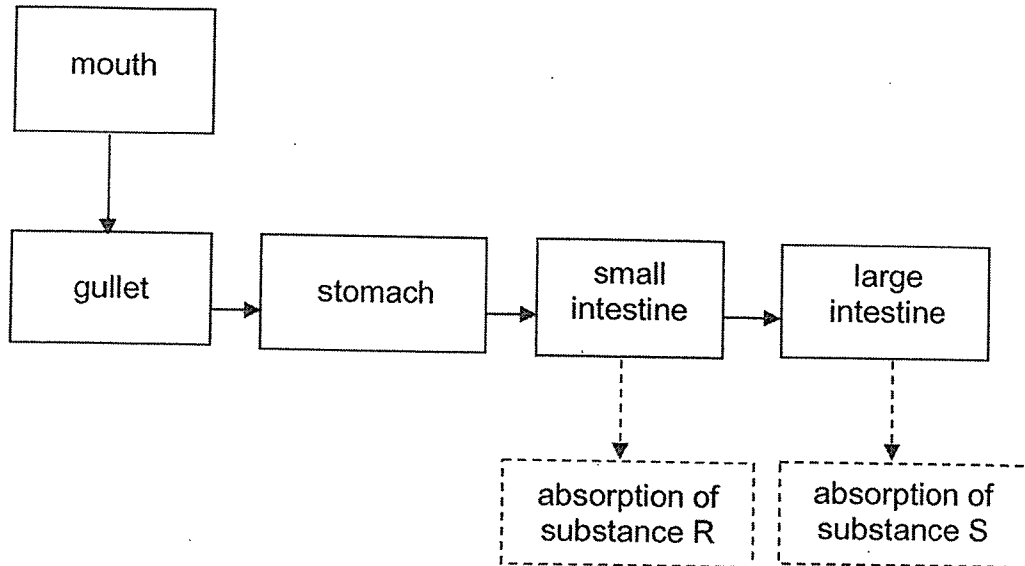

(a) Identify substances R and S in the flowchart.

[2]

R: _____

S: _____

(b) What would possibly happen when the large intestine is not functioning correctly? Explain why.

[1]

29. The flow chart below shows the characteristics of materials Q, R, S and T.

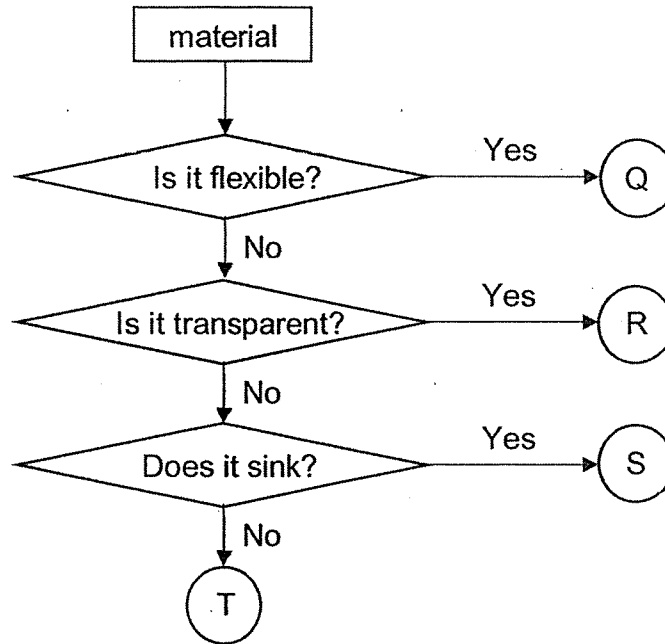

Andy wants to buy a toy boat for his brother to play in the swimming pool.

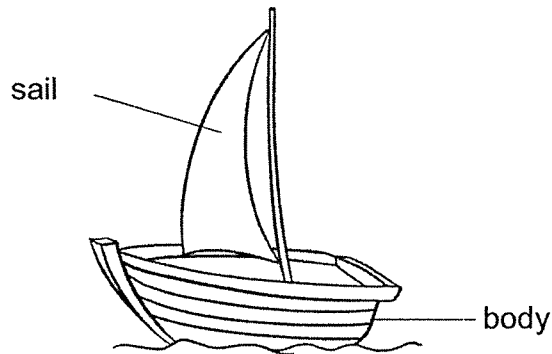

(a) Based on the flow chart above, which material, Q, R, S or T, should the following parts be made of? [2]

(i) Sail: material _____

(ii) Body: material _____

(b) State a similarity between material R and S. [1]

30. Four pieces of similar-sized materials, A, B, C and D, were soaked in water for 10 minutes. The mass of the materials were measured at the start of the experiment and after 10 minutes respectively. Results were shown below.

Material	Mass at the start of the experiment (g)	Mass after 10 minutes (g)
A	10	55
B	20	33
C	30	38
D	50	50

- (a) Explain why the mass of material D did not change after 10 minutes. [1]

- (b) Based on the results, which material, A, B, C or D, is suitable to make a towel? Explain your answer. [2]

31. Study the properties of three materials, W, X and Y, as shown below.

Material \ Property	W	X	Y
Strong	Yes	No	Yes
Waterproof	No	Yes	Yes
Transparent	No	No	No

(a) List all the three properties of material W. [1]

(b) Based on the properties given, state a difference between materials X and Y. [1]

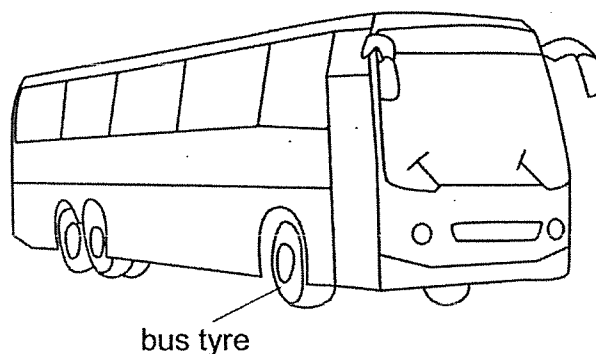

(c) Give an example of a material that is most suitable to make a bus tyre. [1]

(d) Apart from the three properties stated in the table above, state another important property a bus tyre should have. [1]

32. Mary moved a magnet near a tray of steel paper clips as shown below.

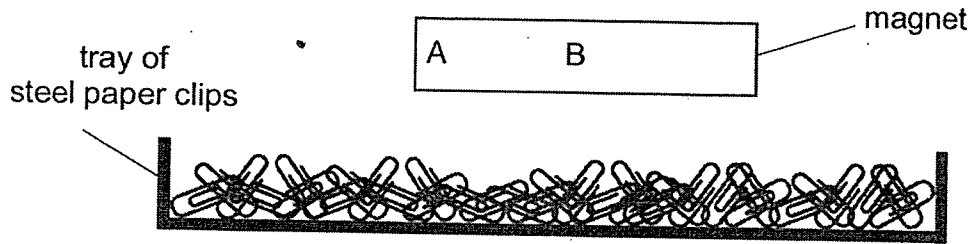

Which part of the magnet, A or B, attracted more steel paper clips?
Explain why.

[2]

33. Rosie placed two identical ring magnets, E and F, through a wooden rod as shown in the diagram below.

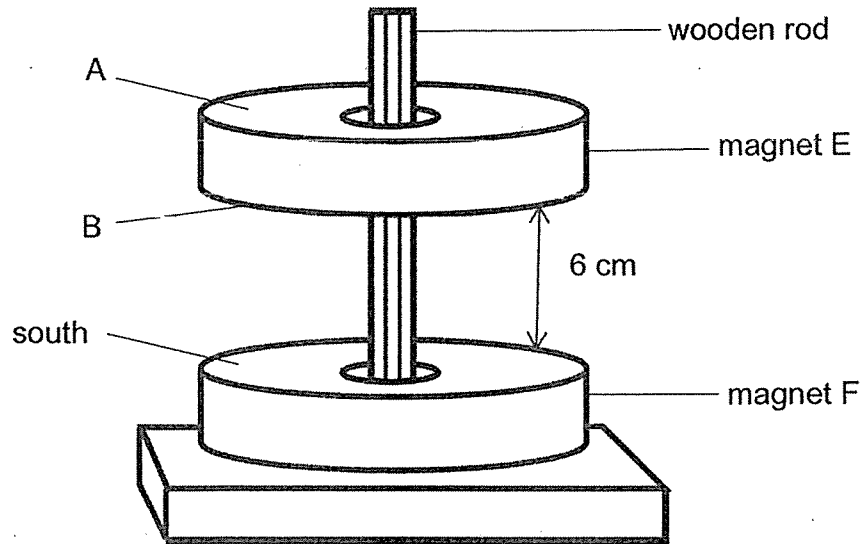

(a) Name the magnetic poles of A and B. [2]

(i) A: _____

(ii) B: _____

(b) Explain why magnet E is floating above magnet F. [1]

Question 33 continues on page 12.

Rosie removed magnet E from the wooden rod and used a hammer to hit it several times. When she placed magnet E back through the wooden rod, she observed that the distance between the two magnets decreased from 6cm to 3cm.

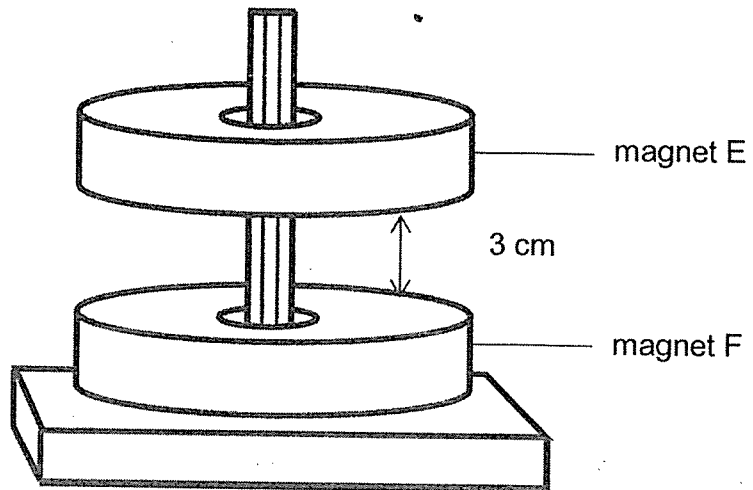

(c) Explain why the distance between the two magnets decreased.

[1]

34. Agnes dropped six iron balls onto the floor and they rolled under a bookshelf. She held a magnet on the floor against the bookshelf to attract one ball at a time. She got two balls using the magnet.

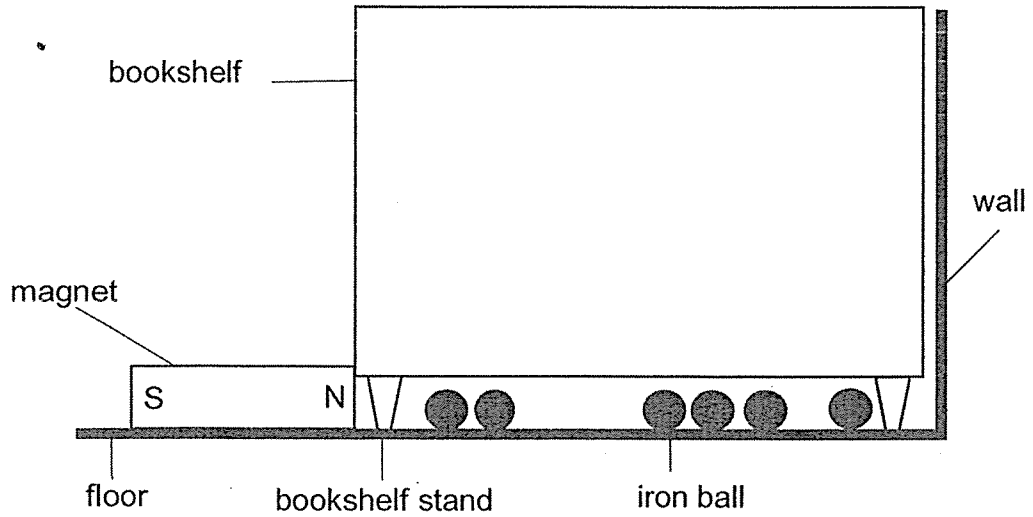

- (a) Give a reason why the other iron balls were not attracted to her magnet. [1]

Question 34 continues on page 14.

Agnes wanted to get the rest of the four iron balls. She tried putting her steel ruler under the bookshelf but it was too short to reach the other four iron balls.

Then she coiled some wire around her steel ruler and connected it to a battery. She pushed the steel ruler under the bookshelf. This time, she got three iron balls.

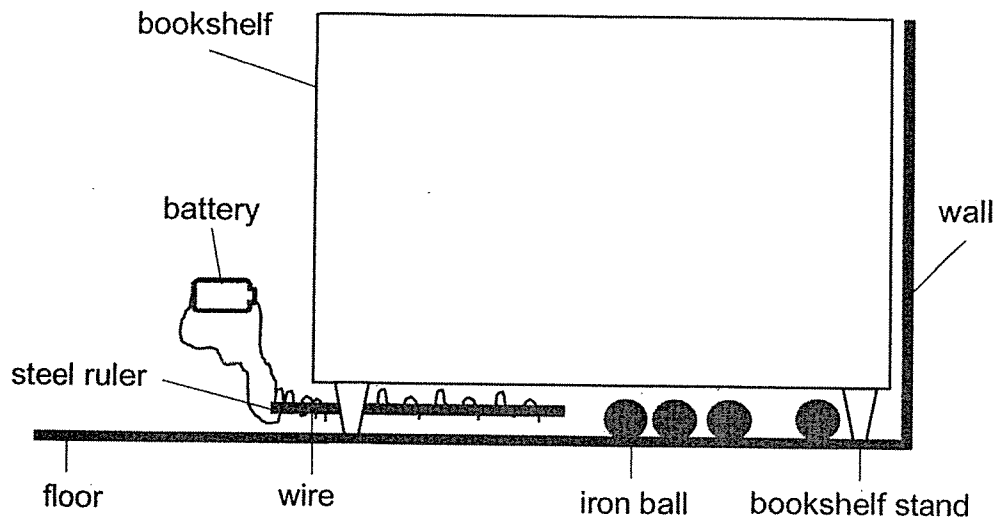

(b) What happened to the steel ruler such that it could attract the three iron balls? [1]

(c) State two changes Agnes could make to her set-up to get the last iron ball. (Do not change the steel ruler.) [2]

(i) _____

(ii) _____

End of Paper

SCHOOL : ROSYTH PRIMARY SCHOOL
 LEVEL : PRIMARY 3
 SUBJECT : SCIENCE
 TERM : 2020 SA2

SECTION A

Q 1	Q2	Q3	Q4	Q5	Q6	Q7	Q8	Q9	Q10
4	2	2	1	4	3	3	3	4	3
Q 11	Q12	Q13	Q14	Q15	Q16	Q17	Q18	Q19	Q20
1	2	1	3	4	2	1	4	2	3
Q 21	Q22	Q23							
3	1	2							

SECTION B

Q24)	a) It increased b) <table border="1" style="margin-left: 20px;"> <tr> <td></td> <td>v</td> </tr> <tr> <td>v</td> <td></td> </tr> <tr> <td></td> <td></td> </tr> <tr> <td></td> <td></td> </tr> </table> c)		v	v					
	v								
v									
Q25)	a) P can make its own food. b) Q has dry skin covered with scales but s does not. c) i)Q ii)S								
Q26)	a) They are spores. b) i)Fungi ii)Plants								
Q27)	a) i)Skeletal system ii)muscular system								

		v
	b)	v
Q28)	a) R: Digested food S: Water b) C- The person would pass out watery stools. E- The large intestine did not absorb enough water.	
Q29)	a) i) Q ii) T b) Both R and S are not flexible.	
Q30)	a) D did not absorb any water at all. b) C – A E – It is the most absorbent. R – A towel has to be absorbent so that it can be used to dry items.	
Q31)	a) W is strong, absorbent and opaque. b) X is weak but Y is strong. c) Rubber d) Flexibility.	
Q32)	C – A E – A is a pole while B is not. R – The poles of a magnet are stronger than other parts of the magnet.	
Q33)	a) i) north ii) south b) They are like poles. c) Magnet E was weakened.	
Q34)	a) They were too far away so the magnets were not strong enough to attract them. b) It was magnetized. c) i) She should add more batteries ii) She could make more coils.	